

LECTURER NOTES ON LAND SURVEY-I



PREPARED BY

MR. SUBRAT KUMAR PANIGRAHI

LECTURER IN CIVIL ENGINEERING,

GOVT. POLYTECHNIC NABARANGPUR

CHAPTER-1

INTRODUCTION

1.1. SURVEYING-

Surveying is the art of determining the relative position of different objects on the surface of the earth by means of measurements of distances, directions and elevations and then, preparing a map to any suitable scale.

TECHNICAL TERMS:

- (i) *Plan*: A plan is a geographical representation of the features on the earth surface or below the earth surface as projected on horizontal plane. This may not necessarily show its geographical position on the globe. On a plan horizontal distances and directions are shown.
- (ii) *Map*: The representation of earth surface on a small scale is called a map. The map must show its geographical position on the globe.
- (iii) *Topographical map*: The maps which are on sufficiently large scale to enable the individual features shown on the map to be identified on the ground by their shapes and positions are called topographical map.
- (iv) *Geographical map*: The maps which are on such a small scale that the features shown on the map are suitably generalized and the map gives a picture of the country as a whole and not a strict representation of its individual features, are called geographical maps.

1.2. AIM AND OBJECTIVES OF SURVEYING-

The aim of surveying is to prepare a map to show the relative positions, horizontal distances, and elevation of the objects on the surface of the earth. The map is drawn to some suitable scale. It shows the natural features of a country, such as towns , villages , roads , railways , river etc. The objectives of surveying can be stated as follows.

- (i) Collect and record data on the relative positions of points on the surface of the earth.
- (ii) Compute areas and volumes using this data,required for various purposes.
- (iii) Prepare the plans and maps required for various activities.

- (iv) Lay out, using survey data, the various engineering works in correct positions.
- (v) Check the accuracy of laid out lines, built of structure.

1.3 CLASIFICATION OF SURVAYING-

(1) PRIMARY CLASSIFICATION

Surveying is primarily classified as:

- (i) Plane surveying
- (ii) Geodetic surveying

(i) *PLANE SURVEYING:*

In plane surveying the curvature of the earth is not taken into consideration. This is because surveying is carried out over a small area so the surface of the earth is consider as plane .Plane surveying is done on an area of less than 250 km².

(ii) *GEODETIC SURVEYING:*

In geodetic surveying the curvature of the earth is taken into consideration. It is extended over a large area. It is carried out over an area exceeding 250 km².

(2) SECONDARY CLASSIFICATION

- (i) Chain surveying
- (ii) Compass surveying
- (iii)Plane table surveying
- (iv)Theodolite surveying
- (v) Tachometric surveying

1.4 GENERAL PRINCIPLE OF SURVEYING-

The two basic principles of surveying need to be followed for accurately locating points on earth.

(i) *To work from the whole to part:*

The main principle of surveying is to work from whole to part whether it is plane or geodetic surveying. To achieve this in actual practice, a sufficient number of primary control points are established with higher precision in and around the area to be detail

surveyed. Minor control points in between the primary control points are then established with less precise method. Further details are surveyed with the help of these minor control points by adopting any of the survey methods. The main idea of working from whole to part is to prevent accumulation of errors and localize minor errors within the frame work of control points. On the other hand if survey is carried out from part to whole, the errors would expand to greater magnitudes and the scale of the survey will be distorted beyond control.

In general practice the area is divided into a number of large triangles and the positions of their vertices are surveyed with greater accuracy, using sophisticated instruments. These triangles are further divided into smaller triangles and their vertices surveyed with less accuracy.

- (ii) *To locate a new station by at least two measurements from fixed reference points / control points.*

The reference points / control points are selected in the area and distance between them, is measured accurately. The line is then plotted to a convenient scale on a drawing sheet. In case, the control points are co-ordinated, their locations may be plotted with the system of coordinates (Cartesian or spherical). The location of the required point may then be plotted by making two measurements from the given control points as explained below.

Let P and Q be two given control points. Any other point R can be located with reference to these points, by any of the following methods.

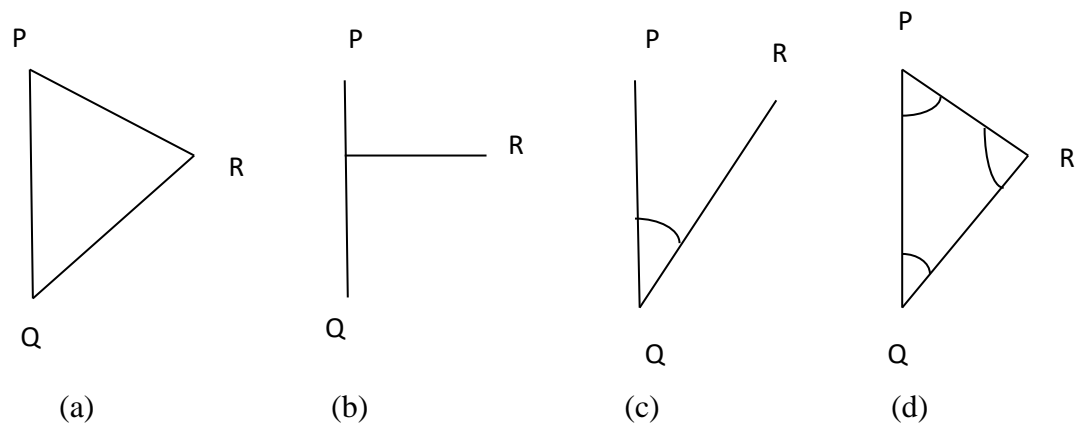

Fig.1

(i) *By measuring distances PR and QR:-* The distances PR and QR may be measured and the location of R may be plotted by drawing arcs to the same scale to which line PQ has been drawn as shown in Fig 1 (a).

(ii) *By dropping a perpendicular from R on PQ:-* A perpendicular RT may be dropped on the line PQ. Distances PT, TQ and RT are measured and the location of R may be plotted by drawing the perpendicular RT to the same scale to which line PQ has been drawn (Fig. 1 (b)).

The above two principles are generally used in “Chain surveying”.

(iii) *By measuring the distance QR and angle PQR:-* The distance QR and the angle PQR equal to α are measured and location of R may be plotted either by means of a protractor or trigonometrically (Fig 1 (c)),

This principle is used in “Theodolite traversing”.

(iv) *By measuring the interior angles of the triangle PQR:-* The interior angles P, Q and R of the triangle PQR are measured with an angle measuring instrument such as theodolites. The length of sides PR and QR are calculated by solving the triangle PQR and coordinates of R are calculated in the same terms as those of P and Q. Even without calculating the co-ordinates, or sides the location of R can be obtained by plotting the angles PQR and QPR (Fig 1(d)).

This principle is used in the method of ‘Triangulation’.

CHAPTER- 2

LINEAR MEASUREMENTS

2.1 INTRODUCTION

There are two main methods of determining the distances between points on the surface of earth:

- (i) *Direct Measurement:* In this method, distances are actually measured on the earth surface by means of **chains, tapes** etc.
- (ii) *Computative Measurement:* In this method distances are determined by calculation as in tachometry and triangulation.

2.2 INSTRUMENTS FOR MEASURING DISTANCES

- (i) Tapes
- (ii) Steel Bands
- (iii) Chains
- (iv) Arrows
- (v) Pegs
- (vi) Ranging Rods
- (vii) Ranging Poles
- (viii) Offset Rods
- (ix) Plumb Bobs

2.3 TAPES: Depending upon the material tapes are classified as

- (i) Cloth or linen tape
 - (ii) Metallic tape
 - (iii) Steel tape
 - (iv) Invar tape
- (i) *Cloth or linen tape:* Linen tapes are closely woven linen and varnished to resist moisture. They are generally 10 metres to 30 metres in length and 12mm to 15 mm in width. Cloth tapes are generally used for measuring offset measurements only due to following reasons :
- (i) It is easily affected by moisture and shrunk.

- (ii) Its length gets altered by stretching.
 - (iii) It is likely to twist and tangle.
 - (iv) It is not strong as a chain or steel tape.
 - (v) It is light and flexible and it does not remain straight in strong wind.
 - (vi) Due to continuous use, its figures get in-distinct.
- (ii) *Metallic Tape:* A linen tape reinforced with brass or copper wires to prevent stretching or twisting of fibers is called a metallic tape. As the wires are interwoven and the tape is varnished, these wires are not visible to naked eyes. These tapes are available in different lengths but tapes of 20m and 30m lengths are very common. These are supplied in leather case with winding machine. Each metre is divided into decimeters and each decimeter is sub-divided into centimeters.
- (iii) *Steel Tape:* Steel tapes are available with different accuracy of graduation. Steel tapes are available in different lengths but 10m, 20m, 30m and 50m tapes are widely used in survey measurements. At the end of the tape a brass ring is provided. The length of metal ring is included in the length of tape. A steel tape of lowest degree of accuracy is generally superior to a metallic or cloth tape for linear measurements.
- (iv) *Invar Tape:* Invar tapes are made of an alloy of nickel (36%) and steel (64%) having very low co-efficient of thermal expansion (0.000000122 per 1°C). These are 6mm wide and are available in length of 30m, 50m and 100m. These tapes are used for high degree of precision required for base measurements.

2.4 **Chains:** The different types of chains are used in surveying and are given below.

(1) *Gunter's chain:* It is 66ft. long and divided into 100 links. Each link measures 0.66 ft.

(2) *Engineer's chain:* It is 100ft. long and divided into 100 links. Each link measures 1 ft.

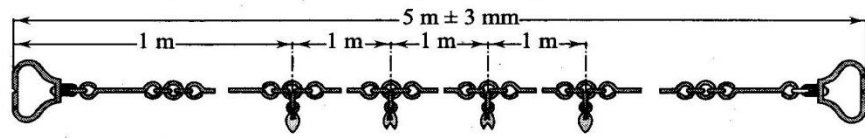

(a) 5-m chain

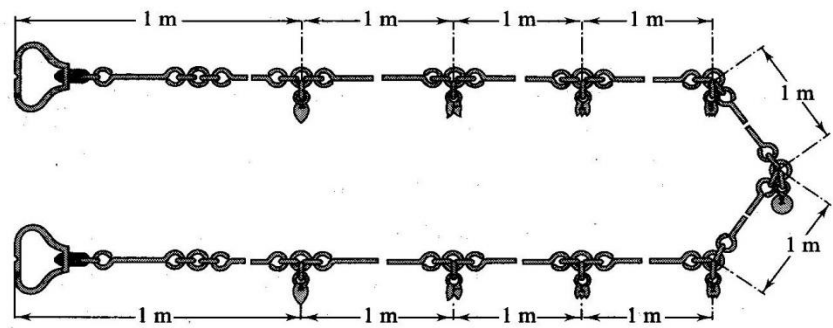

(b) 10-m chain

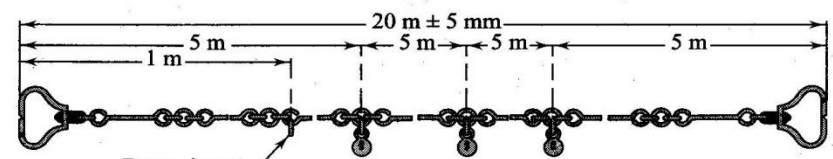

(c) 20-m chain

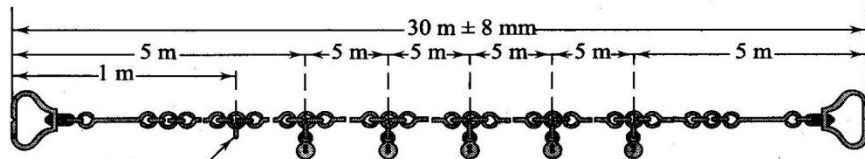

(d) 30-m chain

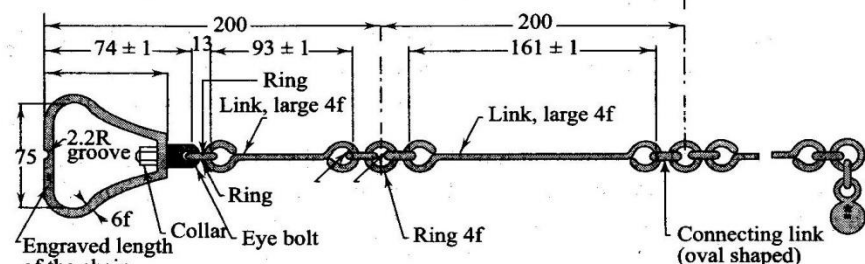

(e) End section of a metre chain

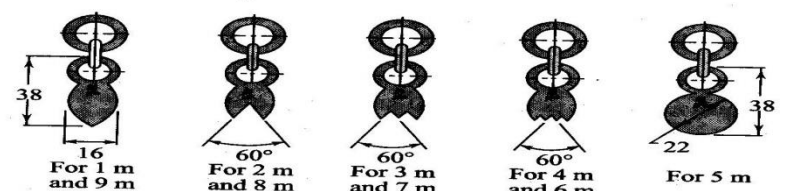

(f) Tallies in metre chains

Fig. Metric chain details

Fig. 2.1

(3) *Metric Chain:* A metric chain is prepared with 100 or 150 pieces/ links of galvanized mild steel wire of diameter 4mm. The ends of the pieces are bent to form loops and connected together by means of three oval shaped rings which gives flexibility to the chain. Two brass handles are provided at the two ends of the chain with swivel joints so that chain can be turned round without twisting. The outside of the handle is the zero point or the end point of the chain. The length of the chain is measured from the outside of one handle to the outside of the other. The length of a link is the distance between the centres of the two consecutive middle rings as shown in the Fig. 2.1. The end links include the length of handle. Tallies are provided for marking 5m, 10m, etc are marked with letter “m” to distinguish the metric chain from non-metric chain. The length of chain whether 20m Or 30m is indicated on the handle for easy identification.

Suitability of Chains: The chains are suitable for the following cases.

- (i) It is suitable for ordinary or preliminary works as its length alters due to continuous use.
- (ii) Its length gets shortened due to bending of links and gets lengthened by flattening of the rings.
- (iii) Being heavier, a chain gets sagged considerably when suspended at the ends.
- (iv) It can be easily repaired in the field.
- (v) Measurement readings can be taken very easily.
- (vi) It is only suitable for rough works.

Merits of Chains:

- (i) They can be read easily and quickly
- (ii) They can withstand wear and tear
- (iii) They can be easily repaired or rectified in the field.

Demerits of Chains:

- (i) They are heavy and take too much time to open or fold.
- (ii) They become longer or shorter due to continuous use.
- (iii) When the measurement is taken in suspension the chain sags excessively giving incorrect measurements.

ARROWS: Arrows are made of tempered steel wire of diameter 4mm. One end of the arrow is bent into a ring of diameter 50 mm and the other end is pointed. Its overall length is 400mm. Arrows are used for counting the number of chains while measuring a chain line. Generally 10 arrows accompany a chain.

RANGING RODS: Rods, which are used for ranging a line are known as ranging rods. Such rods are made of seasoned timber or seasoned bamboo. Sometimes GI pipes of 25mm/ 30mm diameter are also used as ranging rods. They are generally circular in section of diameter 25mm/30mm and length 2m / 3m. The rod is divided into equal parts of 20cm each and the divisions are painted black and white or red and white alternatively so that the rod is visible from a long distance. The lower end of the rod is pointed or provided with an iron shoe.

RANGING POLES: These are similar to ranging rods except that they are heavier in section of length 4m to 6m. They are used for ranging very long lines in undulating ground.

OFFSET RODS: These are similar to ranging rods and are 3m long. The top is provided with an open hook for pulling or pushing a chain through obstruction like bushes etc. It is used for aligning the offset line and measuring short offsets.

PLUMB BOB: It is used to transfer the end points of the chain onto ground while measuring distances in hilly terrain. It is also used for testing verticality of ranging poles, ranging rods.

PEGS: Wooden pegs usually 2.5cm square and 15cm deep are used to mark the position of survey stations.

ADJUSTMENT OF CHAIN: Chains are adjusted in the following ways-

- (1) When the chain is too long, it is adjusted by
 - (a) Closing up the joints of the rings
 - (b) Hammering the elongated rings
 - (c) Replacing some old rings by new rings
- (2) When the chain is too short, it is adjusted by
 - (a) Straightening the bent links
 - (b) Opening the joints of the rings

(c) Replacing the old rings by some larger rings

2.5 ERRORS IN LINEAR MEASUREMENTS / CHAINING

Errors in chaining may be caused due to variation in temperature and pull, defects in instruments etc. They may be classified into two categories.

- (i) Compensating errors
 - (ii) Cumulative error
- (i) *COMPENSATING ERRORS*: Errors, which may occur in both directions (that is both positive and negative) and which finally tend to compensate are known as compensating errors.
- (ii) *CUMULATIVE ERRORS*: Errors, which may occur in the same direction and which finally tend to accumulate are said to be cumulative. They seriously affect the accuracy of the work and are proportional to the length of the line (L). The errors may be positive or negative.

I. *Positive Cumulative Error*: The error, which makes the measured length more than the actual is known as positive cumulative error.

Sources: (a) The length of chain / tape is shorter than its standard length due to

- Bending of links
- Removal of too many rings due to adjustment of its length.
- Knots in connecting links.
- The field temperature is lower than that at which the tape was calibrated.
- Shrinkage of tape when moist
- Clogging of rings with mud.

(b) The slope correction is ignored while measuring along sloping ground.

(c) The sag correction, if not applied when chain / tape is suspended at its ends.

(d) Incorrect alignment.

II. *Negative Cumulative Error*: The error, which makes the measured length less than the actual is known as negative cumulative error.

Sources: (a) The length of chain / tape is longer than its standard length due to

- Flattening of connecting rings.
- Opening of the ring joints.
- The field temperature is higher than that at which the tape was calibrated.

MISTAKES: Errors occurring due to the carelessness of the chainman are called mistakes. Following are a few common mistakes:

- (1) Once an arrow is withdrawn from the ground during chaining it may not be replaced in proper position, if required due to some reason.
- (2) A full chain length may be omitted or added. This happens when arrows are lost or wrongly counted.
- (3) The number may be read from the wrong direction; for instance a 6 may be read as a 9.
- (4) Some number may be called wrongly. For example 50.2 may be called as fifty two without the decimal point being mentioned.

PRECAUTIONS AGAINST ERRORS AND MISTAKES:

- (1) The point where the arrow is fixed on the ground should be marked with a cross(×).
- (2) The zero end of the chain or tape should be properly held.
- (3) During chaining the number of arrows carried by the follower and leader should always tally with the total number of arrows taken.
- (4) The chainman should call the measurement loudly and distinctly and the surveyor should repeat them while booking.
- (5) Ranging should be done accurately.
- (6) No measurement should be taken with the chain in suspension.

ERRORS IN MEASUREMENT DUE TO INCORRECT CHAIN / TAPE LENGTH:

Due to usage of chain over rough ground, its oval shaped rings get elongated and thus the length of chain gets increased. On the other hand, sometimes some of the links get bent and consequently the length of the chain gets decreased. Thus, the lengths obtained by chaining with a faulty chain are either too long or too short than the length which would be obtained with a chain of standard length. *If the chain is too long the measured distance will be less and if the chain is too short the measured distance will be more.*

Let L be the true length of chain and L' be the faulty length of chain.

Then, *the true length of a line* = $\frac{L'}{L} \times \text{measured length}$

2.6 CORRECTIONS IN LINEAR MEASUREMENTS

- (i) Correction for standard length
- (ii) Correction for alignment
- (iii) Correction for slope
- (iv) Correction for tension
- (v) Correction for temperature
- (vi) Correction for sag

(i) *Correction for standard length:* Before using a tape, its actual length is ascertained by comparing it with a standard tape of known length. The designated nominal length of a tape is its designated length e.g. 30m or 100m. The absolute length of a tape is its actual length under specified conditions.

Let L = measured length of a line
 C_a = correction for absolute length
 l = nominal designated length of tape
 C = correction be applied the tape

Then,
$$C_a = \frac{L.C}{l}$$

The sign of the correction C_a will be the same as that of C .

(ii) *Correction for alignment:* Generally a survey line is set out in a continuous straight line. Sometimes, it becomes necessary, due to obstruction to follow a bent line which may be composed of two or more straight portions subtending an angle other than 180° as shown in Fig.2.2.

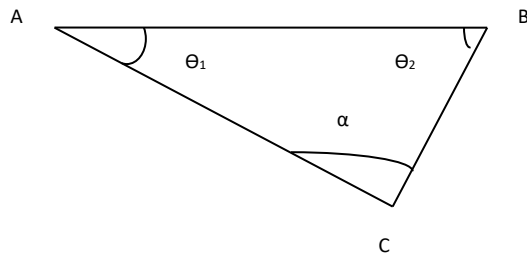

Fig.2.3. Correction for alignment

Let $AC=l_1$; $CB=l_2$
 Angle $BAC = \Theta_1$; Angle $BCA = \Theta_2$
 Length $AB = l_1 \cos \Theta_1 + l_2 \cos \Theta_2$
 The required correction $= (l_1 + l_2) - (l_1 \cos \Theta_1 + l_2 \cos \Theta_2)$

(iii) *Correction for slope*: The distance measured along the slope between two stations is always greater than the horizontal distance between them. The difference in slope distance and horizontal distance is known as slope correction which is always subtractive.

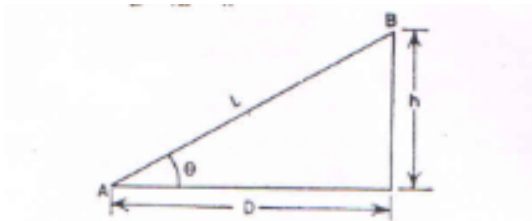

Fig. 2.4 Slope Correction

Let $L =$ slope distance AB
 $D =$ horizontal distance AC
 $h =$ difference in reduced levels of A and B

$$D = \sqrt{(L^2 - h^2)}$$

$$\text{Slope Correction} = L - D = \frac{h^2}{2L}$$

(iv) *Correction for pull/ tension (C_P)*:

During measurement the applied pull may be either more or less than the pull at which the chain or tape was standardized. Due to the elastic property of materials the strain will vary according to the variation of applied pull and hence necessary correction should be applied. This correction is given by the expression

$$C_P = \frac{(P - P_0) \times L}{A \times E}$$

where, P = Pull or tension applied during measurement in Newtons

A = Cross-sectional area of the tape in square cm.

L = Length of the measured line

P_0 = Standard pull

E = Modulus of Elasticity of the tape

If the applied pull is more, tension correction is positive, and if it is less, the correction is negative.

(v) *Temperature correction (C_t):*

This correction is necessary because the length of the tape or chain may be increased or decreased due to rise or fall of temperature during measurement. The correction is given by the expression as mentioned below.

$$C_t = \alpha(T_m - T_0)L$$

where C_t = correction for temperature

α = coefficient of thermal expansion

T_m = temperature during measurement in degrees centigrade

T_0 = temperature at which the tape was standardized in degrees centigrade

L = length of tape

(vi) *Correction for sag (C_s)*

This correction is necessary when the measurement is taken with the tape in suspension. It is given by the expression as mentioned below.

$$C_s = \frac{L}{24} \left(\frac{W}{P} \right)^2$$

where W = total wt of the tape; L = horizontal distance between the supports

P = pull applied during measurement

Problem 1. *The length of a survey line measured with a 30m chain was found to be 631.5m.*

When the chain was compared with a standard chain, it was found to be 0.1m too long. Find the true length of the survey line.

Solution

The true length of a line = $\frac{L'}{L} \times \text{measured length}$

$$L' = 30.1\text{m}. L = 30\text{m}$$

and measured length of the survey line = 631.5m

$$\text{Thus, true length of the survey line} = \frac{30.1}{30} \times 631.5 = 633.603 \text{ m.} \quad \text{Ans.}$$

Problem 2. A 20m chain was found to be 4 cm too long after chaining 1400m. It was 8 cm too long at the end of day's work after chaining a total distance of 2420m. If the chain was correct before commencement of the work, find the true distance.

Solution

The correct length of the chain at commencement = 20m

The length of the chain after chaining 1400m = 20.04 m.

The mean length of the chain while measuring = $(20+20.04)/2 = 20.02\text{m}$

The true distance for the wrong chainage of 1400m = $(20.02/20) \times 1400 = 1401.4 \text{ m}$

The remaining distance = $2420 - 1400 = 1020\text{m}$

The mean length of chain while measuring the remaining distance = $(20.08+20.04)/2 = 20.06\text{m}$

The true length of remaining 1020m = $(20.06/20) \times 1020 = 1023.06\text{m}$

Hence, the total true distance = $1401.4 + 1023.06 = 2424.46 \text{ m}$ Ans.

Problem No.3. A line was measured with a steel tape which was exactly 30 meters at 20°C at a pull of 100N (or 10kgf), the measured length being 1650.00 meters. The temperature during measurement was 30° C and the pull applied was 150N (or 15kgf). Find the length of the line, if the cross-sectional area of the tape was 0.025 sq.cm. The co-efficient of expansion of the material of the tape per 1 °C = 3.5×10^{-6} and the modulus of elasticity of the material of the tape = $2.1 \times 10^5 \text{ N/mm}^2$ ($2.1 \times 10^6 \text{ kg/cm}^2$).

Solution:

(i) Correction of temperature per tape length

$$\begin{aligned} &= \alpha(T_m - T_o)L \\ &= 0.0000035(30 - 20) \times 30 \\ &= 0.00105\text{m (+ve)} \end{aligned}$$

(ii) Correction for pull per tape length

$$= C_P = \frac{(P - P_0) \times L}{A \times E} = \frac{(150 - 100) \times 30}{2.5 \times 2.1 \times 10^5}$$

$$= 0.00286 \text{ m (+ve)}$$

Combined correction = $0.00105 + 0.00286 = 0.00391 \text{ m}$

True length of the tape = $30 + 0.0039 = 30.0039 \text{ m}$

True length of the line = $\frac{(30.0039 \times 1650.00)}{30}$
 $= 1650.21 \text{ m.}$

Ans.

EXERCISE

1. A distance of 2000m was measured by a 30m chain. Later on, it was detected that the chain was 0.1 m too long. Another 500 m (i.e. total 2500 m) was measured and it was detected that the chain was 0.15 m too long. If the length of the chain in the initial stage was quite correct, determine the exact length that was measured.
2. To measure a base line a steel tape 30m long standardized at 15 C with a pull of 100N was used. Find the correction per tape length if the temperature at the time of measurement was 20°C and the pull exerted was 160N, weight of 1 cubic cm of steel is 0.0786N, weight of the tape = 8N. $E = 2.1 \times 10^5 \text{ kg/sq.cm}$, Co-efficient of expansion of the tape per 1°C = 7.1×10^{-7} .
3. A tape 100m long, 6.35mm wide, 0.5 mm thick was used to measure a line, the apparent length of which was found to be 1986.96m. The tape was standardized under a pull of 67.5 N, but after the line was measured, it was found that the pull actually used during the measurement was 77.5 N. What was the true length of the line if the tape was standardized? Take $E = 200000 \text{ N/mm}^2$.

3.0 CHAINING(Chapter-3)

In addition to chain or tape, several other auxiliary equipment are required in a chain surveying. These are listed in subsequent paragraphs.

Arrows

Arrows or chain pins, as these are called sometime, are made of stout steel wire 4 mm in diameter, 400 to 450 mm long and black enameled. These are used to mark the end of each chain length as shown in Figure (a).

Wooden Pegs

These are made of stout timber generally 25 to 30 mm square or circular size and 150 mm long as shown in Figure (b). Wooden pegs are normally used to mark station position on ground on a quasi-permanent state. These are tapered at one end so that they can be driven in the ground with a hammer. These are kept at about 40 mm (minimum) projecting above the ground.

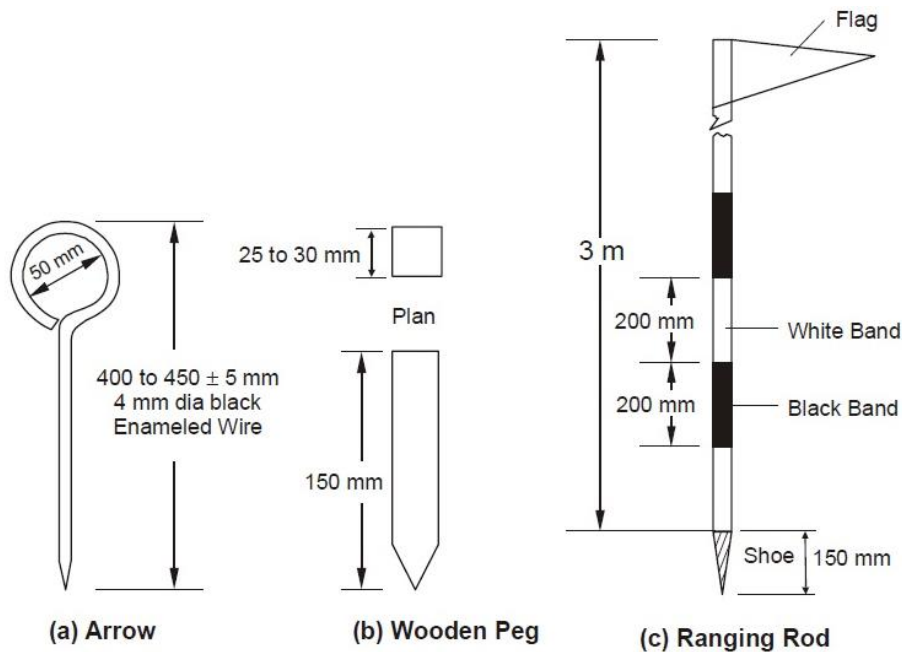

(a) Arrow

(b) Wooden Peg

(c) Ranging Rod



(d) Plumb Bob

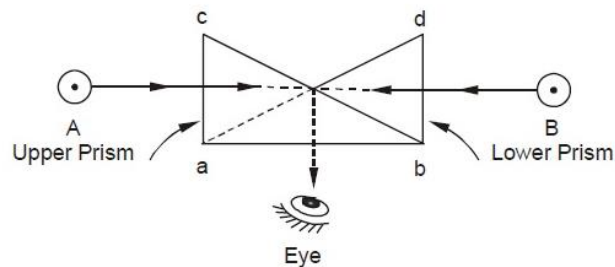

(e) Line Ranger

Ranging Rods

These are octagonal or circular in plan normally 25 to 30 mm diameter straight timber or tubular steel rods, 3 m in length and provided with an iron shoe at lower end as shown in Figure (c). These are painted in black and white alternate bands and normally have a flag at the top for easy recognition and identification from a distance. If the ranging rods are graduated in meters and one tenth of a meter, they are called offset rods and are used for measurement of short offsets.

Plumb Bob

It is usually heavy spherical or conical ball, as shown in Figure (d), of metal and is used to transfer points on ground by suspending it with the help of a strong thread. It is used in measuring distances on sloping ground by stepping. Compass, Dumpy levels and. Theodolites are also positioned over the station point accurately with the help of plumb bobs.

Line Ranger

A line ranger consists of either two plane mirrors or two right angled isosceles prisms placed one above the other as depicted in Figure (e). The diagonals of both the prisms are silvered so as to reflect the incident rays. Line rangers are provided with a handle to hold the instrument. A line ranger can also be used to draw offset on a chain line.

Use of chain

Unfolding Of Chain: To open a chain the strap is unfastened and the two brass handles are held in the left hand and the bunch is thrown forward with the right hand. Then on chainman stands at the starting station by holding one handle and another moves forward by holding the other handle until the chain is completely extended.

Folding of Chain : After the completion of the work the chain should be folded in to a bundle and fastened with a leather strap. To do this the handles of the chain should be brought together by pulling the chain at the middle. Commencing from the middle, take two pairs of link at a time with the right hand and place them obliquely across the other in the left hand. When the chain is collected in a bundle, it is tied with a leather strap. This process is called the folding of chain.

Reading a chain :

A survey chain is generally composed of 100 or 150 links formed by pieces of galvanised mild steel wire of 4 mm diameter. The ends of each link are looped and connected together by means of three circular or oval shaped wire rings to provide flexibility to chain. The length of each link is measured as the distance between the centres of two consecutive middle rings.

The ends of chain are provided with brass handles with swivel joints. The end link length includes the length of handle and is measured from the outside of the handle, which is considered as zero point or the chain end. Tallies, which are metallic tags of different patterns, are provided at suitably specified points in the chain to facilitate quick and easy reading. A semi-circular groove is provided in the centre on the outer periphery of handle of chain for fixing the mild steel arrow at the end of one chain length. The number of links in a chain could be 100 in a 20 m chain and 150 in a 30 m chain. The details of a metric chain are as shown in Figure

Testing of a chain :

Due to continuous use, a chain may be elongated or shortened. So, the chain should be tested and adjusted accordingly. If full adjustment is not possible, then the amount of shortening (known as 'too short') and elongation (known as 'too long') should be noted clearly for necessary correction applicable to the chain.

For testing the chain, a test gauge is established on a level platform with the help of standard steel tape. The steel tape is standardised at 20⁰C and under a tension of 8 kg. The test gauge consist of two pegs having nails at the top and fixed on a level platform a required distance apart (say 20 or 30m). The incorrect chain is fully stretched by pulling it under normal tension along the test gauge. If the length of the chain does not tally with standard length, then the attempt should be made to rectify the error. Finally the amount of elongation or shortening should be noted.

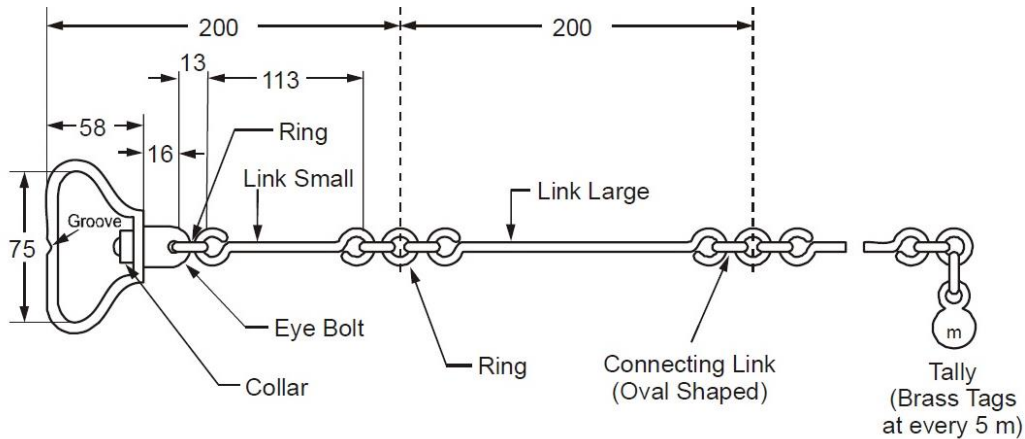

Details of Metric Chain

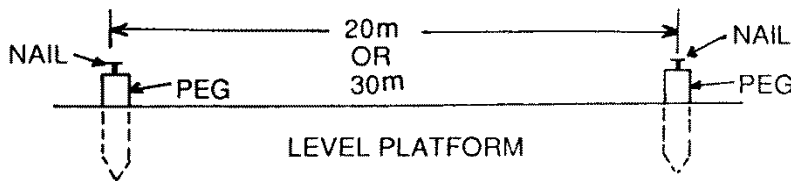

The allowable error is about 2mm per 1m length of the chain. The overall length of the chain should be within the following permissible limit :

20 m chain : ± 5 mm

30m chain : ± 8 mm

Adjustment of a chain :

Chains are adjusted in the following ways :

- When the chain is too long, it is adjusted by :
 - Closing the opened joints of the rings.
 - Reshaping the elongated rings.
 - Removing one or more circular rings.
 - Replacing the worn-out rings.

- When the ring is too short, it is adjusted by:
 - Straightening the bent links.
 - Flattening the circular rings .
 - Inserting the new rings where necessary.
 - Replacing the old rings by some larger rings.

Ranging :

The process of establishing intermediate points on a straight line between two end points is known as ranging.

Purpose of ranging :

The purpose of ranging is to mark a number of intermediate points on a survey line joining two stations in the field so that the length between them may be measured correctly.

If the line is short or its end station is clearly visible, the chain may be laid in true alignment. But if the line is long or its end station is not visible due to undulation ground, it is required to mark a number of points with ranging rods.

Code of Signals for Ranging

Sl.No.	Signal by the Surveyor	Action by the Assistant
1	Rapid sweep with right hand	Move considerably to the right
2	Slow sweep with right hand	Move slowly to the right
3	Right arm extended	Continue to move to the right
4	Right arm up and moved to the right	Plumb the rod to the right
5	Rapid sweep with left hand	Move considerably to the left
6	Slow sweep with left hand	Move slowly to the left
7	Left arm extended	Continue to move to the left
8	Left arm up and moved to the left	Plumb the rod to the left
9	Both hands above head and then brought down	Correct
10	Both arms extended forward horizontally and the hands depressed briskly	Fix the rod

Direct ranging :

When intermediate ranging rods are fixed along the chain line, by direct observation from either end station, the process is known as “Direct Ranging”. Direct ranging is possible when the end stations are inter visible. The following procedure is adopted for direct ranging :

- Erect ranging rods or poles vertically behind each end of the line.
- Stand about 2m behind the ranging rod at the beginning of the line.
- Direct the assistant to hold a ranging rod vertically at arm’s length at the point where the intermediate station is to be established.
- Direct the assistant to move the rod to the right or left , until the ranging rods appear to be exactly in a straight line.
- Stoop down and check the position of the rod by sighting over their lower ends in order to avoid error to non-vertically of the ranging rods.
- After ascertaining that the ranging rods are in a straight line, signal the assistant to fix the ranging rod.

Indirect ranging :

When the end stations are not inter visible due to there being high ground between them, intermediate ranging rods are fixed on the line in an indirect way. This method is known, as indirect ranging or reciprocal ranging. The following procedure is adopted for indirect ranging.

Suppose A and B are two end stations which are not intervisible due to high ground existing between them. Suppose it is required to fix intermediate points between A and B. Two chain men take up positions at R_1 and S_1 with ranging rods in their hands. The chainman at R_1 stands with his face towards B so that he can see the ranging rods at S_1 and B. Again the chainman at S_1 stands with his face towards A so that he can see the ranging rods at R_1 and A. Then the chainmen proceed to range the line by directing each other alternately. The chainman at R_1 direct the chainman at S_1 to come to position S_2 so that R_1 , S_2 and B are in the same straight line. Again the chainman at S_2 directs the chainman at R_1 to move the position at R_2 so that S_2 , R_2 and A are in the same straight line. By directing each other alternately in this manner, they change their positions every time until they finally come to the positions R and S, which are in the straight line AB. This means the points A, R, S and B are in the same straight line.

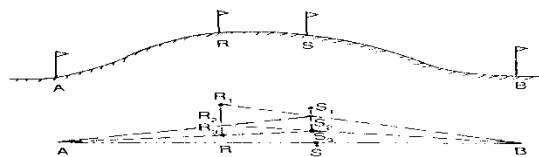

Role of Leader and Follower :

The chainman at forward end of the chain, who drag the chain forward, is known as leader. The duties of the leader are as follows:

- a. To drag the chain forward with some arrows and a ranging rod.
- b. To fix arrows on the ground at the end of every chain.
- c. To obey the instructions of the follower.

The chainman at the rear end of the chain, who holds the zero end of the chain at the station, is known as the follower. The duties of the follower are :

- a. To direct the leader at the time of ranging.
- b. To carry the rear handle of the chain.
- c. To pick up the arrows inserted by the leader.

Chaining on Level Ground :

Before starting the chaining operation two ranging rods should be fixed on the chain line, at the end stations. The other ranging rods, should be fixed near the end of each chain length, during the ranging operation.

To chain the line, the leader moves forward by dragging the chain and by taking with him a ranging rod and 10 arrows . The follower stands at the starting station by holding the other end of chain. When the chain is fully extended , the leader holds the ranging rod vertically at arm's length. The follower directs the leader to move his rod to the left or right until the ranging rod is exactly in line. Then the follower holds the zero end of the chain by touching the station peg. The leader stretches the chain by moving it up and down with both hands, and finally places it on the line. He then inserts an arrow on the ground at the end of the chain and marks with a cross (X).

Again, the leader moves forward by dragging the chain with nine arrows and the ranging rod. At the end of the chain, he fixes another arrow as before. As the leader moves further, the follower picks up the arrows which were inserted by the leader. During chaining the surveyor or an assistant should conduct the ranging operation.

In this way, chaining is continued. When all the arrows have been inserted and the leader has none left with him, the follower hands them over to the leader; this should be noted by the surveyor. To measure the remaining fractional length, the leader should drag the chain beyond the station and the follower should hold the zero end of the chain at the last arrow. Then the odd links should be counted.

Chaining on Sloping Ground:

Chaining on the surface of a sloping ground gives the sloping distance. For plotting the surveys, horizontal distances are required. It is therefore, necessary either to reduce the sloping distance to horizontal equivalent or to measure the horizontal distances between the stations directly. The following are the different methods that are generally employed.

- a) Direct Method or Stepping Method
- b) Indirect Method

Direct Method:

This method is applied when slope of the ground is very steep. In this method, the sloping ground is divided into a number of horizontal and vertical strips, like steps. So, this method is also known as stepping method. The length of the horizontal portions are measured and added to get the total horizontal distance between the points. The steps may not be uniform, and would depend on the nature of the ground.

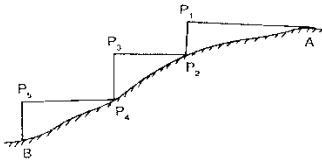

Procedure:

Suppose the horizontal distance between points A and B is to be measured.

The line AB is first ranged properly.

Then, the follower holds the zero end of the tape at A.

The leader selects a suitable length AP_1 so that P_1 is at chest height and AP_1 is just horizontal.

The horizontal is maintained by eye estimation, by tri-square or by wooden set-square.

The point P_2 is marked on the ground by plumb-bob so that P_1 is just over P_2 .

The horizontal length AP_1 is noted then the follower moves to the position P_2 and holds the zero end of the tape at that point.

Again the leader selects a suitable length P_2P_3 in such a way that P_2P_3 is horizontal and P_3P_4 vertical.

Then the horizontal lengths P_2P_3 and P_4P_5 are measured.

So the total horizontal length, $AB = AP_1 + P_2P_3 + P_4P_5$

Indirect Method :

When the slope of the ground surface is long and gentle, the stepping method is not suitable. In such a case, the horizontal distance may be obtained by the indirect methods. Those are of following types.

- a. By measuring the slope with clinometers.
- b. By applying hypotenusal allowance
- c. By knowing the difference of level between the points.

a. Measuring slope with a clinometer :

A clinometer is a graduated semicircular protractor. It consists of two pins P_1 and P_2 for sighting the object. A plum bob is suspended from point O with a thread. When the straight edge is just horizontal, the thread passes through 0° . When the straight edge is tilted, the thread remains vertical, but passes through a graduation on the arc which shows the angle of slope.

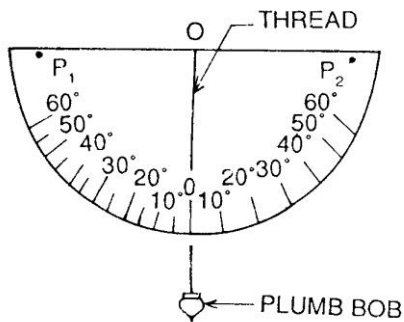

Suppose C and D are two points on sloping ground. Two ranging rods are fixed at these points. Then two other points C_1 and D_1 are marked on the ranging rods so that $CC_1 = DD_1$

The clinometer is placed in such a way that its centre just touches the mark C_1 . The clinometer is then inclined gradually until the points P_1 , P_2 , and D_1 are in the same straight line. At this position the thread of the clinometer will show an angle which is the angle of slope of the ground. Suppose this angle is α . The sloping distance CD is also measured.

The required horizontal distance = $CB = l \cos \alpha$

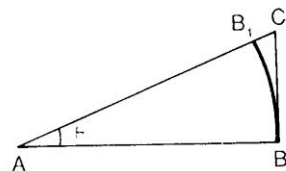
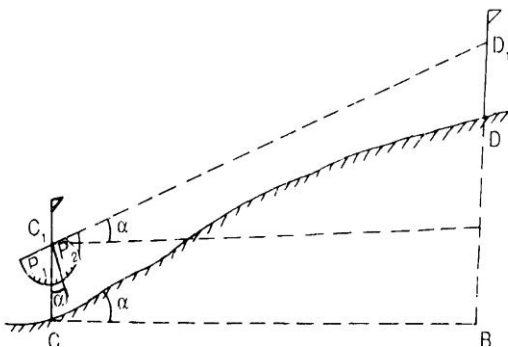

b. Applying hypotenusal allowance

In this method, the slope of the ground is first out by using the clinometers. Hypotenusal allowance is then made for each tape length.

Let θ = angle of slope measured by clinometers

$$AB = AB_1 = 20\text{m} = 100 \text{ links}$$

$$AC = AB \sec\theta = 100 \sec \theta$$

$$\begin{aligned} B_1C &= AC - AB_1 \\ &= 100 \sec \theta - 100 \\ &= 100 (\sec\theta - 1) \end{aligned}$$

Obstacle:

A chain line may be interrupted the following situations:

1. When chaining is free, but vision is obstructed.
2. When chaining is obstructed, but vision is free, and
3. When chaining and vision are both obstructed

1. Chaining free but vision obstructed:

Such a problem arises when a rising ground or a jungle area interrupts the chain line. Here the end stations are not inter-visible.

Case – I

The end stations may be visible from some intermediate points on the rising ground. In this case, reciprocal ranging is resorted to, and the chaining is done by stepping method.

Case – II

The end stations are not visible from intermediate points when jungle are comes across the chain line.

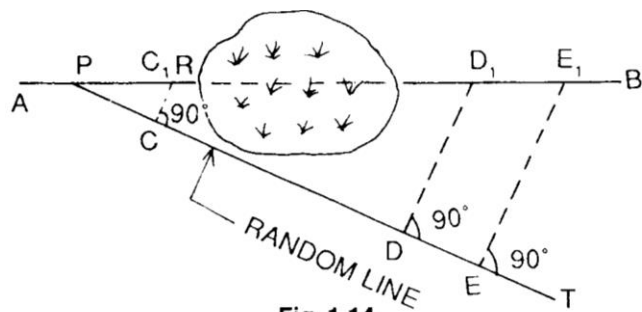

Fig. 1.14

Let **AB** line be the actual chain line which can not be ranged and extended because of interruption by a jungle. Let line extended up to **R**. A point **P** is selected on the chain line and a random line **PT** is taken in a suitable direction. Points **C**, **D** and **E** are selected on the random line and perpendiculars are projected from them. The perpendicular at **C** meets the line at **c₁**

Theoretically,

$$\frac{DD_1}{PD} = \frac{CC_1}{PC}$$

$$DD_1 = \frac{CC_1}{PC} \times PD \dots\dots\dots (1)$$

Again from triangle **PEE₁** and **PCC₁**

$$\frac{EE_1}{PE} = \frac{CC_1}{PC}$$

$$EE_1 = \frac{CC_1}{PC} \times PE \dots\dots\dots (2)$$

From eq 1 and 2, the lengths **DD₁** and **EE₁** are calculated. The distance is measured along the perpendiculars at **D** and **E**. Points **D₁** and **E₁** should lie in the chain line **AB**

$$\text{Distance } PE_1 = \sqrt{PE^2 + EE_1^2}$$

2. Chaining obstructed but vision free:

Such a problem arises when a pond or river comes across the chain line. The stations may be tackled in the following ways.

Case – I

When a pond interrupts the chain line, it is possible to go around the obstruction.

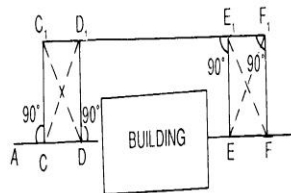
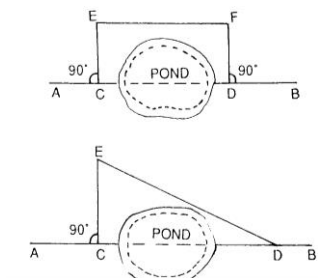

$$CD = EF$$

$$CD = \sqrt{ED^2 + CE^2}$$

3. Chaining and vision both obstructed :

Such a problem arises when a building comes across the chain line. It is solved in the following manner.

Suppose AB is the chain line. Two points C and D are selected on it at one side of the building. Equal perpendiculars CC_1 and DD_1 are erected. The line C_1D_1 is extended until the building is crossed. On the extended line, two points E_1 and F_1 are selected. Then perpendiculars E_1E and F_1F are so erected that

$$E_1E = F_1F = D_1D = C_1C$$

Thus, the points C, D, E and F will lie on the same straight line AB

Here, $DE = D_1E_1$

The distance D_1E_1 is measured, and is equal to the required distance DE.

Problem :

A chain line ABC crosses a river, B and C being on the near and distant banks respectively. The line BM of length 75 m is set out at right angles to the chain line at B. If the bearings of BM and MC are $287^\circ 15'$ and $62^\circ 15'$ respectively, find the width of the river.

Solution :

$\angle BMC = \text{BB of BM} - \text{FB of MC}$

i.e. $\alpha = (287^\circ 15' - 180^\circ 00') - 62^\circ 15' = 45^\circ 00'$

From triangle MBC, $\frac{BC}{BM} = \tan 45^\circ 00'$

$BC = BM \tan 45^\circ 00' = 75 \text{ m}$

So the width of river is 75 m.

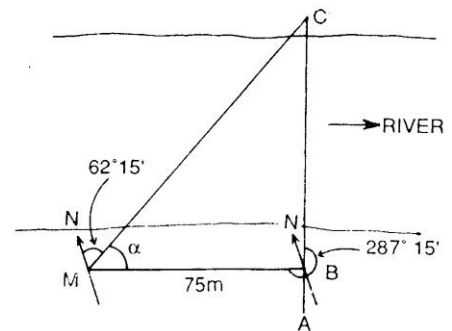

4.0 CHAIN SURVEYING

Definition:

The chain surveying is one of the method of land surveying. It is the system of surface in which sides of different triangular are measured directly in the field and no angular measurement are taken.

Principle of Chain Surveying:

The principle of chain surveying is triangulation. This means that the area to be surveyed is divided in to a number of small triangles which should be well conditioned. In chain surveying the sides are directly measured by chain or tape.

Chain surveying is recommended when:

1. The ground surface is more or less leveled.
2. A small area is to be surveyed.
3. A small – scale map is to be prepared and
4. The formation of well conditioned triangles is easy

Chain surveying is unsuitable when:

1. The area is crowded with many details.
2. The area consists of too many details.
3. The area is very large.
4. The formation of well – conditioned triangles becomes difficult due to obstacles.

Well Conditioned Triangle:

1. A triangle is said to be well – conditioned when no angle is less than 30° or greater than 120° . An ideal triangle is considered to be best conditioned or ideal triangle.
2. Well conditioned triangles are preferred because their apex points are very sharp and can be located by single ‘dot’.

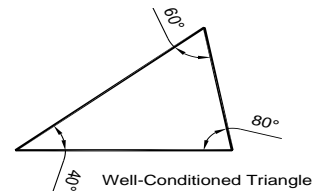
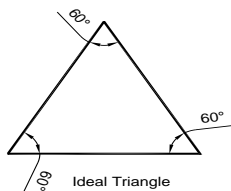

ILL – Conditioned Triangle:

1. A triangle in which an angle is less than 30° and greater than 120° is said to be ill-conditioned triangle.
2. Ill conditioned triangles are not used in chain surveying.

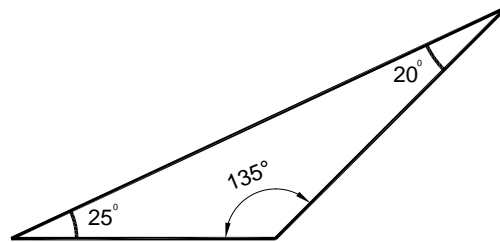

Ill-Conditioned Triangle

Accessories in chain survey

The following equipments are required for conducting chain survey:

- | | |
|----------------------------------|----------|
| 1. Metric chain (20 m) | = 1 no |
| 2. Arrows | = 10 nos |
| 3. Metallic tape (15m) | = 1 no |
| 4. Ranging rods | = 3 nos |
| 5. Offset rod | = 1 no |
| 6. Clinometer | = 1 no |
| 7. Plumb bob with thread | = 1 no |
| 8. Cross staff or optical square | = 1 no |
| 9. Prismatic compass with stand | = 1 no |
| 10. Wooden pegs | = 10 nos |
| 11. Mallet | = 1 no |
| 12. Field book | = 1 no |
| 13. Good pencil | = 1 no |
| 14. Pen knife | = 1 no |
| 15. Eraser | = 1 no |

Reconnaissance Survey and Index Sketch:

During reconnaissance survey, the surveyor should walk over the area and note the various obstacles and whether or not the selected stations are inter-visible. The main station

should be so selected that they enclose the whole area. The surveyor should be take care that the triangles formed are well-conditioned.

The neat hand sketch of the area which is prepared during reconnaissance survey is known as “index sketch” or “key plan”. The index sketch shows the skeleton of survey work.

Selection of Surveying Stations:

Survey stations are the points at the beginning and the ending of a chain line. The stations are classified under 3 categories

- i.e* - (a) Main Station
(b) Subsidiary Station
(c) Tie Station

1. Main survey station at the end of chain line should be inter-visible.
2. Survey line should be minimum as possible.
3. The main principle of surveying such as working from whole to part and from part to whole.
4. The stations should be well conditioned triangle.
5. Every triangle should be provided with a check line.
6. Tie line should be provided to avoid too long offsets.
7. Obstacles to ranging and chaining if any should be avoided.

The larger side of the triangle should be placed parallel to the boundaries, roads, buildings, etc. to have short offsets.

1. Chain line should be lie over leveled ground.
2. Line should be laid on one side of the road to avoid disturbance of chaining by passing of traffic.

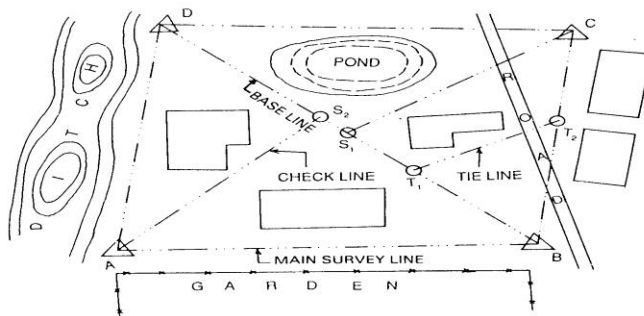

INDEX SKETCH

Base line:

The line on which the frame work of the survey is built is known as the “Base line”. It is the most important line of the survey work. Generally, the longest of the main survey line is considered as base line.

Tie line:

The tie line is a line which joins subsidiary stations on the main line.

Check line:

The line joining the apex point of triangle to some fixed point on its base is known as check line. It is taken to check the accuracy of the triangle.

Offset:

The lateral measurement taken from an object to the chain line is known as offset. Offsets are taken to locate objects with reference to the chain line. They are two types:

- I. Perpendicular Offset
- II. Oblique Offset

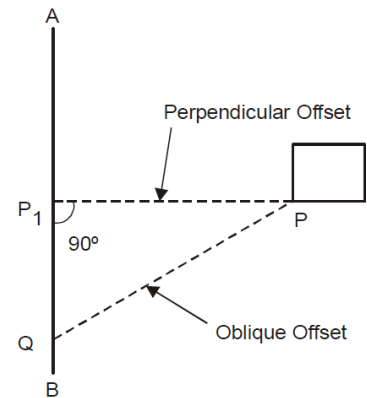
**Perpendicular Offset:**

When the lateral measurement for fixing the detail points are made perpendicular to the chain line. The offsets are known as perpendicular offset.

Oblique Offset:

When the lateral measurement for fixing the detail points are made at any angle to the chain line. The offsets are known as oblique offset. It can be done by following two(2) process

i.e -

- a. Long offset
- b. Short offset

Setting offset with chain and tape (Manual methods)

3-4-5 Offset

Perpendicular offset of chain line at any point A is obtained using the following mathematical expression ($3^2 + 4^2 = 5^2$). A point B is located on chain line at a distance of

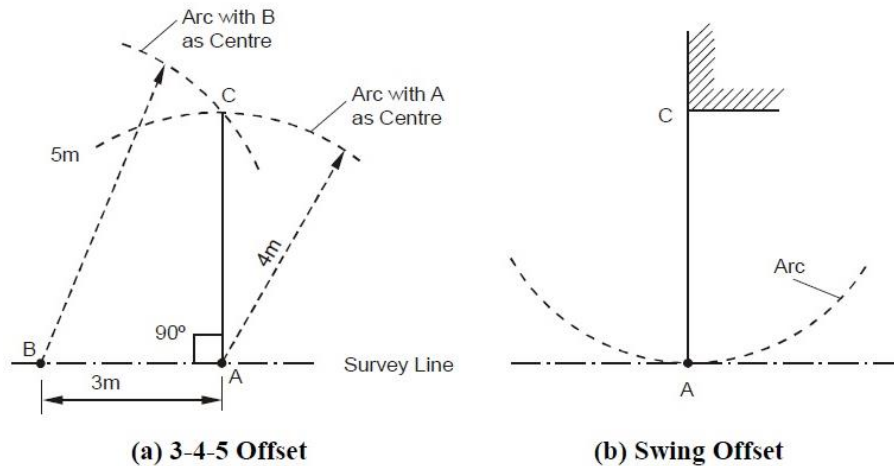

3 m from A such that $AB = 3$ m. Next, an arc is set on ground with centre at A and radius equal to 4 m. Another arc is laid with center at B and radius equal to 5 m intersecting the previous arc at C as shown in Figure (a). Line AC will then be perpendicular to line AB.

Swing Offset

The perpendicular distance of an important feature, e.g. building corner, from the chain line is measured using swing offset method. The zero end of tape is kept at point of interest (Figure (b)) and point A (i.e. normal from C on chain line) is located by swinging the tape with C as center. The point A is characterized by a point at which the arc generated by swing is tangential to survey line and the distance of C from any point on chain line is minimum.

It may be noted that usually only small offsets can be set by manual methods.

Optical Square:

1. It is a most suitable instrument for setting out a line at a right angle to another line.
2. It consists of a circular metal box about 5c.m. in diameter and 1.25c.m. in deep. It consists of two inclined mirrors at an angle of 45° .
3. The upper glass is known as *horizontal* glass and the lower end glass is known as *index* glass.

Principle:

If the two mirrors are inclined with the surface at an angle of 45° . The plane is successfully reflected under deviation of twice the angle.

Uses:

1. It is used to find out foot of perpendicular to the chain line.
2. To set out a perpendicular to a chain line.

Cross staff:

The cross-staff consists of four metal arms with vertical slits. The two pairs of arms are at right angles to each other. The vertical slits are meant for sighting the ranging rods. The cross-staff is mounted on a wooden pole of length 1.5m. and diameter 2.5c.m. The pole is fitted with an iron shoe.

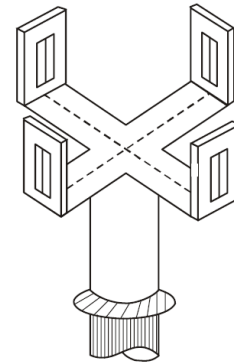

Cross Staff

Limiting Length of Offset:

The maximum length of the offset should not be more than the length of the tape used in the survey. Generally, the maximum length of offset is limited to 15 m. however, this length also depends upon the following factors:

- (a) The desired accuracy of the map
- (b) The scale of the map
- (c) The maximum allowance deflection of the offset from its true direction
- (d) The nature of ground

Sources of Errors :

Errors may arise from three sources :

(1) Instrumental

Error may arise due to imperfection or faulty adjustment of the instrument with which measurement is being taken. For example, a tape may be too long or an angle measuring instrument may be out of adjustment. Such errors are known as instrumental errors.

(2) Personal

Error may also arise due to want of perfection of human sight in observing and of touch in manipulating instruments. For example, an error may be there in taking the level reading or reading an angle on the circle of a theodolite. Such errors are known as personal errors.

(3) Natural

Error may also be due to variations in natural phenomena such as temperature, humidity, gravity, wind, refraction, and magnetic declination. If they are not properly observed while taking measurements, the results will be incorrect. For example a tape may be 20 metres at 20⁰C but its length will change if the field temperature is different.

Field Book:

1. The book in which the chain or tape measurements are entered or sketched of detail points are recorded is called field book.
2. Its size is 20c.m.X 12c.m.
3. The chain line may be represented about 1.5c.m. to 2.0c.m. a part rolled down the middle of each page.
4. The chain line is started from the bottom of page and work up words.
5. It should be well bounded and a size of convenient for the pocket.
6. All distance along the chain line are entered either to the left or to the right of the chain line.
7. The new line should be started from a new fresh page and name of line should be noted at the foot and booking proceeds from the bottom of the page to up wards.
8. At the different feature within the offset are reached, surveyor draw them and enters the chain and length of each offset.
9. Field books may be two types
 - I. Single Line
 - II. Double Line

Single-Line Field Book

In this type of field book , a single red line is drawn through the middle of each page. This line represents the chain line and the chainages are written on it. The offsets are recorded with sketches to the left or right of the chain line.

Double-Line Field Book

In this type of field book, two red lines, 1.5 cm apart, are drawn through the middle of each page. This column represents the chain line, and the chainages are written in it. The offsets are recorded with sketches to the left or right of this column.

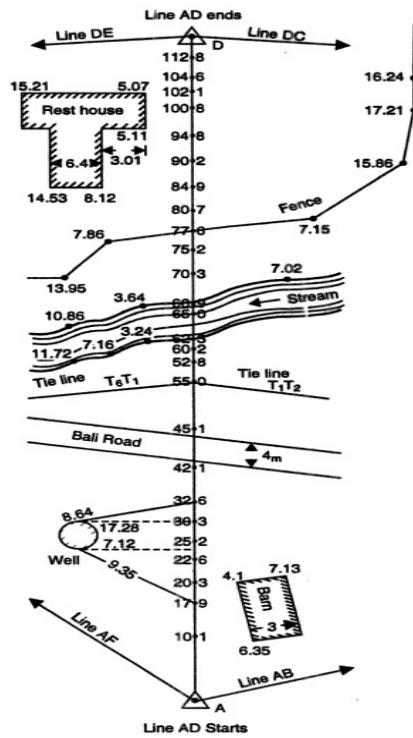

SINGLE LINE BOOKING.

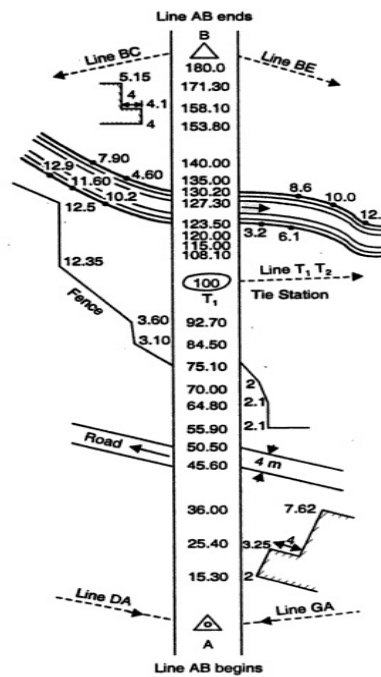

DOUBLE LINE BOOKING.

EQUIPMENTS OF PLOTTING:

Following are the equipments of plotting

1. Drawing board (normal size – 1000 mm X 700 mm)
2. Tee – Square
3. Set – square (45° and 60°)
4. Protractor
5. Cardboard Scale
6. Instrument box
7. Drawing sheets

Procedure for plotting:

1. A suitable scale is chosen so that the area can be accommodated in the space available in the map.
2. A margin of about 2 cm. from the edge of the sheet is drawn around the sheet.
3. The north line marked on the right-hand corner, and should perfectly be vertical. When it is not convenient to have a vertical north line, it may be inclined to accommodate the whole area within the map.
4. The framework is completed with all survey lines, check lines and tie lines. If there is some plotting errors which exceeds the permissible limits, the incorrect lines should be resurveyed.
5. The plotting of offsets should be continued according to the sequence maintained in the field book.
6. The conventional symbols are used in the map should be shown on the right – hand side.
7. The scale of the map is drawn below the heading or in some suitable space. The heading should be written on the top of the map.
8. Unnecessary lines, objects, etc. should be erased.
9. The map should not contain any dimensions.

Recommended scales for some of the types of map could be

(a) **Geographical Maps** : 1/25000 to 1/100000 and even smaller. Atlas maps and wall maps

could even have smaller scales.

(b) **Topographical Maps** : 1/25000 to 1/250000 showing natural and man-made features and

contours.

(c) **Cadastral or Land Revenue Maps** : 1/500 to 1/5000, relatively larger scales showing

holdings of individuals. Used for tax/revenue collection and for planning and management.

(d) **Building Sites, Town Planning Schemes etc.** : 1/5000 to 1/10000, for building sites larger scale, e.g. 1/1000 can be used.

(e) **Roads, Railway Lines or Canal Maps** : Longitudinal sections can be drawn to a horizontal scale of 1/1000 to 1/20000 while for vertical plots the scales are 1/100 to 1/200. For plotting cross sections, both horizontal and vertical scales are 1/100 to 1/200.

It can be noted that on many maps with smaller scales, many important land features cannot be plotted to scale. However, these, being important details, cannot be ignored. Hence, these are represented on map sheet by suitable conventional symbols.

Some of the conventional symbols approved by Bureau of Indian Standard (BIS) are as shown in Figure.

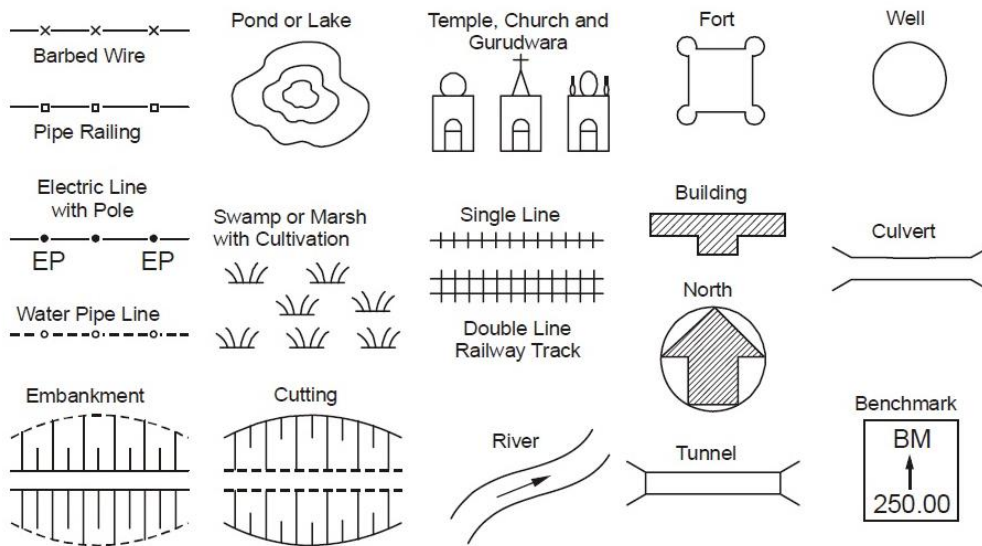

Important Symbols

ERRORS IN CHAIN SURVEYING:

Errors in chaining may be caused due to variation in temperature and pull, defects in instruments, etc. They may be either;

1. Compensating Error
2. Cumulative Error

Compensating Error:

Errors which may occur in the both directions (i.e. both positive and negative) and which finally tend to compensate are known as compensating errors. They are proportional to \sqrt{L} , where \sqrt{L} - is the length of the line. Such error may be caused by

1. Incorrect holding of the chain.
2. Inaccurate measurement of right angles with chain, tape.
3. Horizontality and verticality of steps not being properly maintained during the stepping operations.
4. Fractional parts of the chain or tape not being uniform throughout its length

Cumulative Error:

Errors which may occur in the same direction and which finally tend to accumulate. They seriously affect the accuracy of work, the length of the line (L).

Positive Error: when the measured length is greater than the actual length, (the chain length is too short), the error is said to be positive error. Such error occurs due to:

- (a) The length of chain or tape being shorter than the standard length.
- (b) Slope correction not being applied.
- (c) Correction for sag not being made.
- (d) Measurement being taken with faulty alignment.
- (e) Measurement being taken in high winds with the tape in suspension.

Negative Error: When the measured length is less than the actual length, (the chain length is too long), the error is said to be negative. These errors occur when length of chain or tape is greater than the standard length due to the following reasons:

- (a) The opening of ring joints.
- (b) The applied pull being much greater than the standard.
- (c) The temperature during measurement being much higher than standard.
- (d) Wearing of connecting rings.
- (a) Elongation of the links due to heavy pull.

Precautions against Error:

Following are the precautions should be taken to guard against errors and mistakes.

1. The point where the arrow is fixed on the ground should be marked with a cross (X).
2. The zero end of the chain or tape should be properly held.
3. The chain man should call the measurement loudly and distinctly and the surveyor should repeat them while booking.
4. During chaining, the number of arrows carried by the follower and leader should always tally with the total numbers of arrows taken.
5. Measurements should not be taken with tape in suspension in high wind.
6. In stepping operations, horizontality and verticality should be properly maintained.
7. Ranging should be done accurately.
8. No measurement should be taken with the chain in suspension.
9. Care should be taken so that the chain is properly extended.

CHAPTER-5

5.0 ANGULAR MEASUREMENT:

Compass:

The compass works on the principle that a freely suspended magnetic needle takes the direction of the magnetic lines of force at a place. This provides us a reference direction with respect to which all angles can be measured.

There are two types of compasses

1. The prismatic compass
2. The surveyor's compass.

The surveyor's compass is rarely used in comparison purposes. The principle of the operation of both the compass is the same but they are made differently used in the field

1) The prismatic compass.

It is the most suitable type of surveying compass which consists of a circular box about 100 mm in diameter.

It can be used as a hand instrument or on a tripod.

It can be accurately centered over ground station marks.

The main parts of a prismatic compass is as follows

Magnetic Needle:

The magnetic needle is the most important of the measurement. The needle, generally of the board form, is supported on a hard, steel pivot with an agate tip. When not in use, the needle can be lifted off the pivot, by a lifting needle, actuated by the folding of the objective vane. This is done to ensure that the pivot tip is not subjected to undue wear. The magnetic needle should be perfectly symmetrical and balanced at its midpoint on the hard pointed pivot. It should be weighted with an adjustable weight to compensate for the dip angle. The needle should be sensitive and take up the north-south direction speedily. The needle should lie in the same horizontal plane as the pivot point, and a vertical plane should be made in such a way that the centre of gravity of the needle lies as much below the pivot point as possible.

Graduated ring:

An aluminum graduated ring 85 to 110 mm diameter is attached in the needle on its top a diametrical arm of the ring. Aluminum, being a non-magnetic substance, is used to ensure that the ring does not influence the behavior of the needle. The

graduation of the ring is from 0 to 360°. 0°/360° is marked on the south end of the needle and the graduation go in a clockwise direction., with 90° marked on the west, 180 on the north, and 270° on the east directions. The graduations are marked to half degrees, but it is possible to read the angle as per least count.. The graduations on the ring are inverted as they are to be read by a prism.

Eye vane prism:

The point on the prismatic compass from where the straighting is done is known as the eye vane, which is made up of a rectangular frame to the graduated ring when it is folded over the glass plate cover of the compass. The prism has convex surfaces, which magnify the graduations on the ring. A metal cover is used to cover the reading face of the prism when it is not in use. The prism can be raised or lowered on the metal frame for adjusting to the eye of the observer. Dark glasses may be provided on the frame, which can be brought in view while shiting bright objects to reduce glare.

Object vane:

Diametrically opposite the eye vane the object vane, which is a metal frame hinged at the bottom for folding over the glass cover when it is not in use. A fine silk thread or hair is shifted on the frame vertically, which can be used to bisect a ranging rod or the hair id fitted on the frame vertically, which can be used to bisect a ranging rod or other objects. When the frame is folded over the glass cover, it pressing against a pin, which actuates the lifting lever of the needle and lifts the needle off the pivot. Also fitted below this frame on the box is a brake pin, which, when, gently passed, stops the oscillation of the needle by pressing against the graduated aluminium ring. The object vane may be provided with mirrors, which can be moved over the frame for sighting objects at a height or far below.

Compass Box:

The needle and other fittings are enclosed in a metal box with a glass cover to prevent dust. The two vanes are also attached to the box at diametrically opposite ends. The box is attached to a metal plate through a ball and socket arrangement for leaving the compass. While the compass may also be used by holding it in the hand, it is preferable to use it with a tripod, for which the metal plate has a screwed end that can be attached to a tripod. The compass box can be carried in a leather pouch when not in use.

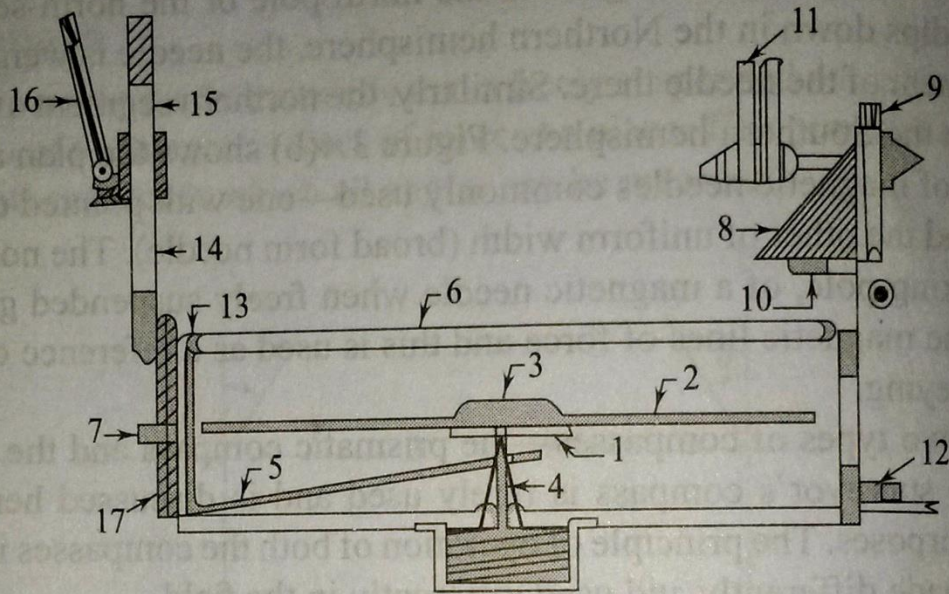

- | | | | |
|-----------------|------------------|-------------|-------------------------------|
| 1 Needle | 2 Aluminium ring | 3 Agate cap | 4 Pivot |
| 5 Lifting lever | 6 Glass cover | 7 Brake pin | 8 Prism |
| 9 Eye vane | 10 Prism cover | 11 Sunglass | 12 Focusing knob
for prism |
| 13 Lifting pin | 14 Object vane | 15 Hair | 16 Mirror |
| 17 Box | | | |

(a) Details of a prismatic compass

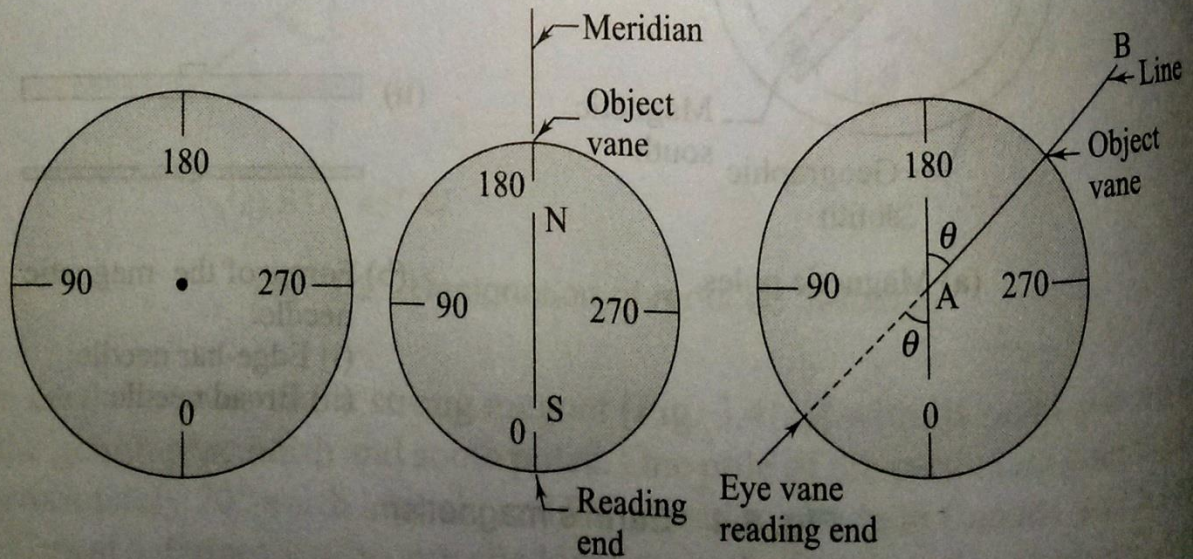

(b) Graduations on the ring

(c) Reading of a bearing

Use of Prismatic Compass:

The following steps are required in using prismatic compass.

1. Setting up and centering screw the prismatic compass onto the tripod and place the tripod over the station. it is centered over the tripod. Centering is done by adjusting the tripod legs.
2. Level the compass using the ball and socket arrangement. Levelling is done approximately so that the needle can move freely in a plane, after opening the objective and eye vanes.
3. Open the object vane and eye vane see that needle moves freely. Direct the object vane towards the ranging rod or any other objects at the next station. Sighting is done by bisecting the object with the cross hair on the object vane while looking through the eye vane. The prism of the eye vane has to be adjusted for a clear view of the graduations by moving it up or down. It is clear that the graduated ring along with the attached needle always points to the north direction while the box is rotated with the vanes. The line of sight between the stations is through the eye vane and the cross hair of the object vane and should pass through the centre of the pivot.
4. Once the object has been clearly sighted, damp the oscillation of the needle with the damping pin if required. Once the object has been pinned if required. Once the needle comes to rest, looking through the prism, record the reading at the point on the ring corresponding to the vertical hair seen directly through the slit in the prism holder.

Graduation on ring:

It is clear from the graduations that the prismatic compass gives the WCBs of the lines. The reading taken through the prism has to be zero when the line of sight is pointing to the north. The reading taken through the prism has to be zero when the line of sight is pointing to the north. The reading end is the south end of the needle. Therefore, the zero graduation is marked at the south end .

Temporary adjustments:

At every station where prismatic compass is placed, The following adjustments, as described above, have to be made: centering leveling, and focusing the prism. The prism has to be focused once if the same person has to take the prism. The prism has to be focused only once if the same person has to take the readings. Centering is done by adjusting only the legs to bring

the compass exactly over the station. Leveling is done to ensure that as the compass is rotated it moves very nearly in a horizontal plane and the needle moves freely.

Surveyor's Compass

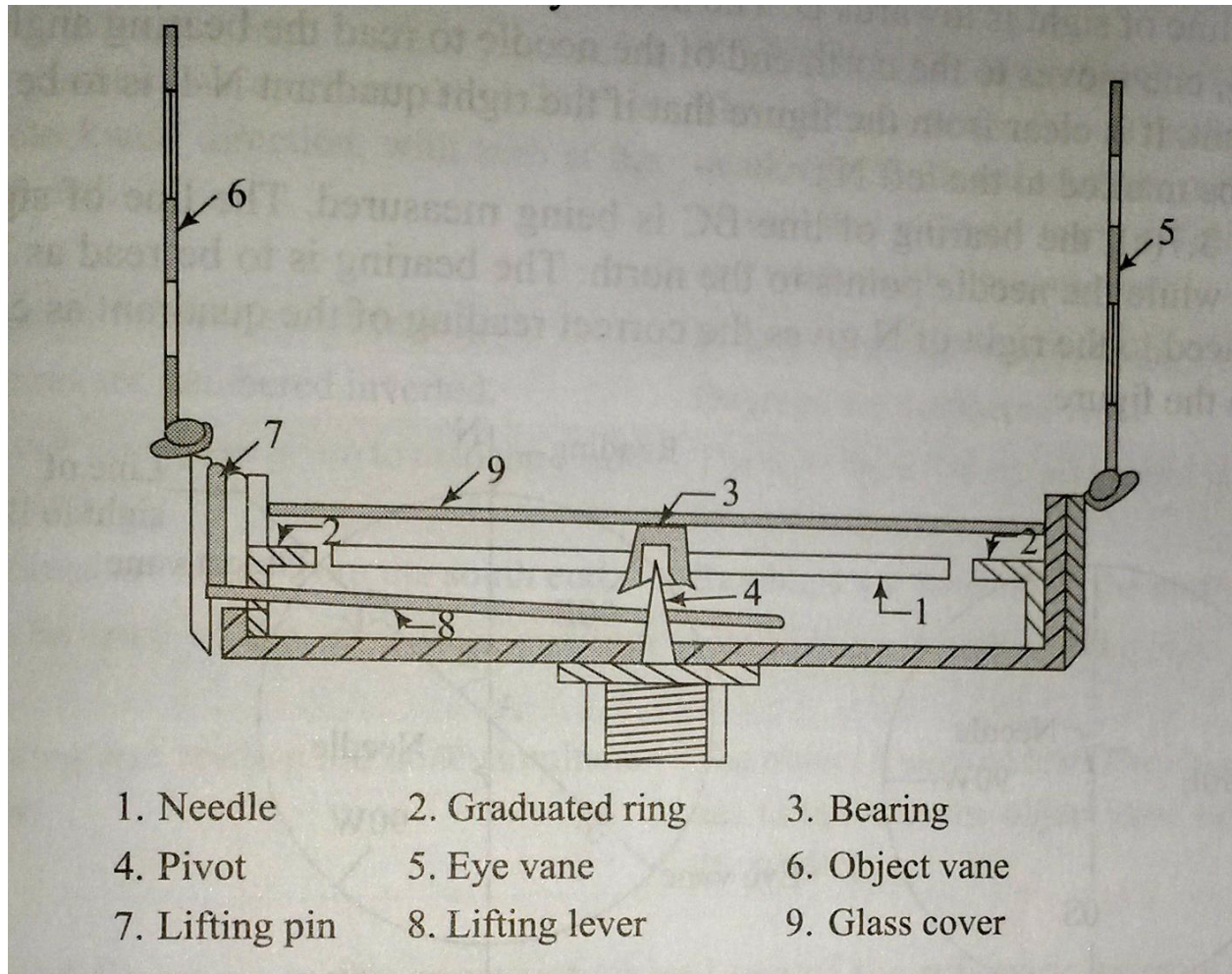

The surveyor's compass is an old type of instrument finding rare use today. A brief description of the instrument is given below. The surveyor's compass has the following components.

Magnetic needle: The edge bar magnetic needle rests on a pivot of hard metal and floats freely.

Graduation ring:

The graduated ring is not attached to the needle but to the cover box of the compass and inside it. The graduations are in the quadrantal system. The letters N, W, S, and E are marked on the ring along with graduations from 0° to 90° in each quadrant. The graduations are marked to Half-degrees but can be read to one-fourth of a degree by

judgement. The E and W half-degrees but can be read in the ring. The moves with the compass as the box is rotated for sighting, the needle pointing to the north always.

Object vane and eye vane:

The object vane consists of a fine thread or hair fitted onto a metal frame for sighting objects. The eye vane is a similar frame with a fine slit but has no prism to read the graduations.

Base and tripod:

The surveyor's compass cannot be used without a tripod. A base with a ball and socket arrangement and a screwing end for the tripod is used.

An arrangement for lifting the needle off the pivot is provided. This is actuated when the object vane is folded onto the cover glass.

Using surveyor's compass:

The following steps are required.

1. Attach the compass box to the tripod. Place the tripod over the station and centre and level the instrument.
2. Rotate the instrument to bring the object vane in line with the ranging rod at the adjacent station. Looking through the eye vane, finely bisect the ranging rod.
3. Note the reading, by going around to the objective vane side, at the north end of the needle by looking through the glass. Take the reading along with the quadrant by noting down the letters on either side of the reading.

Graduation on ring:

Fig explain the graduations on the ring. N and S are marked along the north-south direction. E and W are marked along the east-west direction but their positions are interchanged, with E marked to the left of N and W to the right of the N. This is done to ensure that the correct quadrant is noted when the reading is taken at the north end of the needle.

Fig , shows the bearing of line AB being measured. The compass is at A and the line of sight is towards B. The needle points to the north direction. After sighting B, one moves to the north end of the needle to read the bearing angle and the quadrant. It is clear from the figure that if the right quadrant N-E is to read, E should be marked to the left N.

In fig the bearing of line BC is being measured. The line of sight is along BC while the needle points to the north. The Bearing is to read as N-W, and W placed to the right of N gives the correct reading quadrants as can be seen from the figure.

Comparison Between Prismatic and Surveyor's Compasses:

The prismatic compass and the surveyor's compass are both based on the same principle of orientation of a magnetic needle along the north-south direction. Both the instruments measure magnetic bearings.

Differences between the prismatic compass and surveyor's compass

Sl no		Prismatic Compass	Surveyor's Compass
1	Magnetic needle	It has a broad needle but does not act as an index.	It has an edge bar needle and act as an index.
2		The graduated ring is attached with the needle. This does not rotate along with the line of sight.	The graduated ring is fixed to the box and is independent of needle.
3		The graduations are in W.C.B system having zero at the south end. It ranges from 0° to 360° in the clockwise direction. The graduations are engraved inverted.	The graduations are in Q.B.system having North and south are marked with 0° where as east and west are marked with 90°. It ranges from 0 to 90. East and west are also interchangeable. The graduations are engraved erect.
		The eye vane has a prism to read the graduated ring.	The eye vane has no prism and is not used for reading.
		Can be used in the hand-held position also	Has to be used with a tripod only.
		Sighting and reading are done simultaneously from one position of the observer.	Sighting and reading cannot done simultaneously from one position of the observer

Meridians:

The fixed direction on the surface of the earth with reference to which bearings of survey lines are expressed is called as Meridians .

Bearing:

The horizontal angle between the reference meridian and the survey line measured in a clockwise direction is call bearing.

There are four different types of meridians which can be used as reference directions.

True meridian:

The true or geographic meridian at a point is the line of intersection of a plane passing through the north and south poles and the point with the surface of the earth. Since the earth is approximately a sphere, it is clear that the meridians through different points meet at the north and south poles. The true meridians through different points are not parallel. The true meridian at a place can be established through astronomical observations. The direction of the true meridian remain constant. If the magnetic bearing of the sun is taken at noon, the location of the true meridian at the point can be found. The sun is taken at noon is on a plane passing through the north and south poles at a place. The true bearing of survey line is the horizontal angle that line makes with the true meridian passing through one of its ends.

Magnetic meridian:

The magnetic meridian through a point on the ground is the direction taken by a freely suspended magnetic needle placed at that point. The magnetic meridian can be affected by any serious magnetic interference. Such as an overhead electric cable or the presence of magnetic substance, such be explained later. The magnetic bearing of a survey line is the horizontal angle compass measures the magnetic bearing of a line.

Grid Meridian :

State survey maps are based on one or more true meridians of places so that they placed centrally. The north-south lines of the grid are parallel to the line representing the central meridian. The direction of the grid lines along the north-south direction is known as Grid Meridian. The bearing of survey lines referred to and reckoned from grid lines are called Grid Bearing.

Arbitrary meridian:

The arbitrary meridian at a point is any well-defined direction between any two points, such as the spire of a church, a well-defined point on the ground, or a tower. Such meridians can be used for local surveys as they will serve the purpose of a reference direction, and the required computations are possible with such data. The arbitrary bearing of a line is the horizontal angle between the line direction and the direction of the arbitrary meridian through one end of the line.

Designation of Bearings:

The bearing of survey lines are designated in the following systems

1. Whole Circle bearing system (W.C.B)
2. Quadrantal bearing system (Q.B)

1. Whole circle bearing system (WCB):

In this system of bearing of a line measured from the true north or magnetic north in clockwise direction. The value of bearing may vary from 0 to 360. It is also known as Azimuthal System.

2. Quadrantal Bearing system (WCB):

In this system of bearing of a line measured eastward or westward from the north or south whichever is nearer. In this system both North and South direction are used as reference meridians. The bearings are measured either clockwise or anticlockwise depending upon the position of the survey line. It is also called Reduced Bearing.

Conversion of bearings:

If the WCBs are given, convert them to quadrantal or reduced bearings. Similarly, QBs can also be converted to WCBs.

Whole circle bearing to reduced bearing:

To convert WCB (measured clockwise from the north direction) to RBs, the following simple rules are followed.

- If the WCB is less than 90° , the RB is numerically equal to the WCB. The quadrant designation is N-E.
- If the WCB is between 90° and 180° , the RB is equal to $180^\circ - \text{WCB}$. The quadrant designation is S-E.
- If the WCB is between 180° and 270° , the RB is equal to $\text{WCB} - 180^\circ$. The quadrant designation is S-W.
- If the WCB is between 270° and 360° , the equal to $360^\circ - \text{WCB}$. The quadrant designation is N-W.

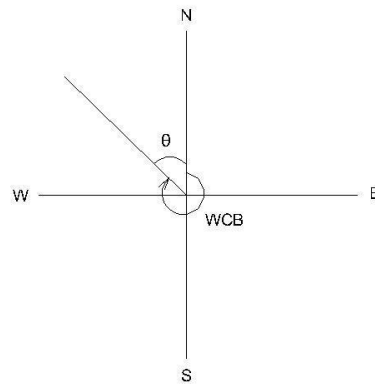
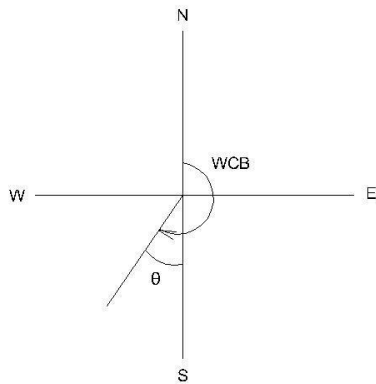
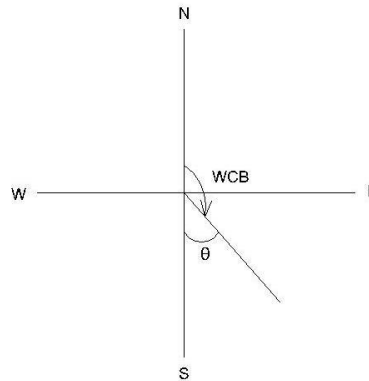
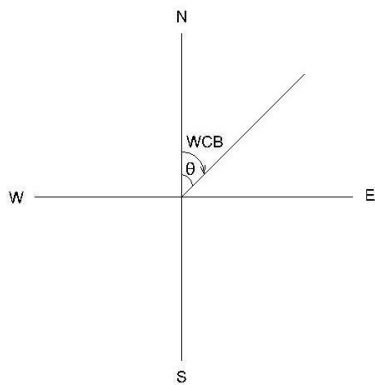

Quadrantal bearing to whole circle bearing:

To convert given QBs to WCB, the following simple rules are to be followed.

- If the quadrant designation is N-E, the WCB is numerically equal to the RB.
- If the quadrant designation is S-E, the WCB is equal to $180^\circ - \text{QB}$.
- If the quadrant designation is S-W, the WCB is equal to $180 + \text{QB}$.
- If the quadrant designation is N-W, the WCB is equal to $360^\circ - \text{QB}$.

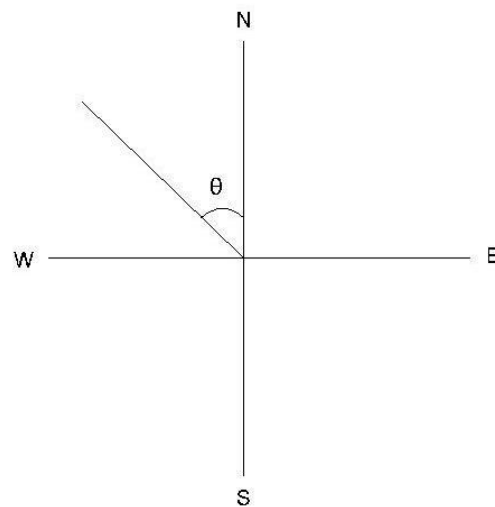
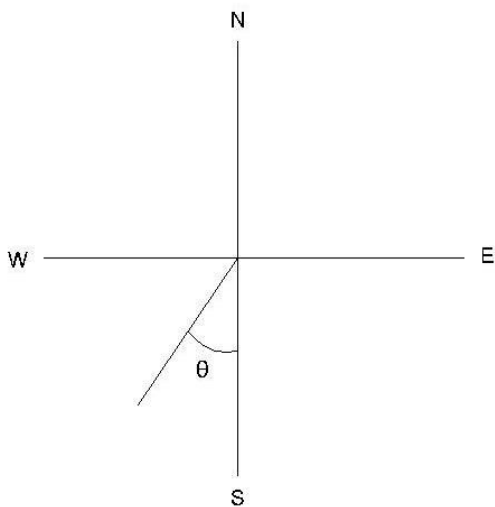
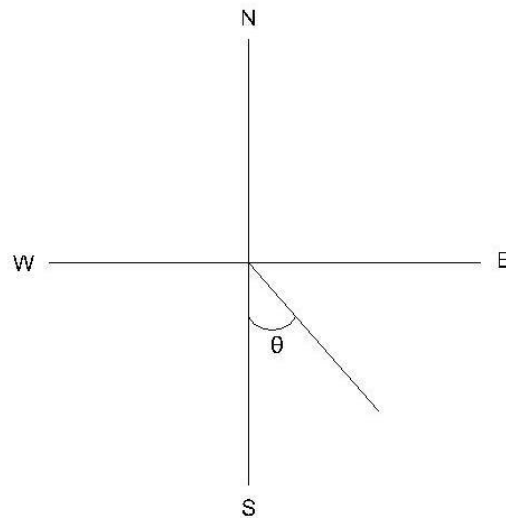
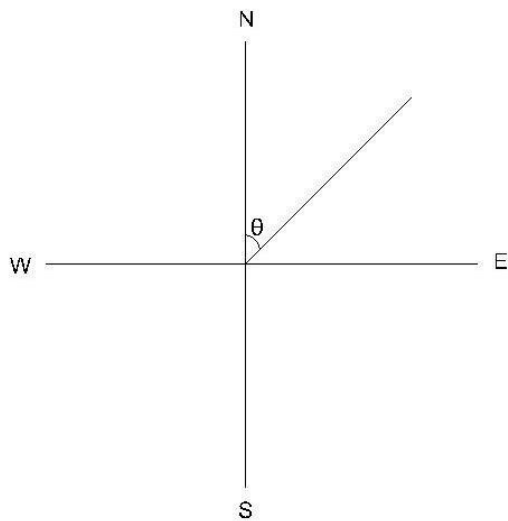

Example : Convert the following WCBs to RBs and RBs to WCBs.

- a) $187^{\circ}30'$, $48^{\circ}15'$, $295^{\circ} 0'$, $126^{\circ} 30'$
 b) $N30^{\circ}30'W$, $S45^{\circ}15'E$, $S38^{\circ}15'W$, $N49^{\circ}30'E$.

Sol.:

- a)
 $187^{\circ}30'$ This lies in the S-W quadrant. $RB = 187^{\circ}30' - 180^{\circ} = S7^{\circ}30'W$
 $48^{\circ}15'$ lies in the N-E quadrant. $RB = N 48^{\circ}15' E$
 $295^{\circ} 00'$, this lies in the N-W quadrant. $RB = 360^{\circ} - 295^{\circ} = N65^{\circ}00'W$
 $126^{\circ} 30'$ this lies in the S-E quadrant. $RB = 180^{\circ} - 126^{\circ} 30' = S 53^{\circ}30'E$

b)

N30°30'W This lies in the N-W quadrant. WCB= 360°00'- 30°30'= 329°30'
S45°15'E, This lies in the S-E quadrant. WCB= 180°00'- 45°15' = 134°45'
S38°15'W, This lies in the S-W quadrant. WCB= 180°00'+S38°15' = 218°15'
N49°30'E. This lies in the N-E quadrant. WCB = 49°30'

Fore and Back Bearings:

Fore Bearing :

The bearing of a line in the direction of progress of the survey is called Fore or forward Bearing(FB).

Back Bearings:

The bearing of a line in the opposite direction of progress of the survey is called Back Bearing(BB).

The relation between the FB& BB is

$$\text{Back Bearing} = \text{Fore Bearing} \pm 180^\circ$$

Use + sign if FB is less than 180° & Use - sign if FB is greater than 180°

If the fore bearing is given, in the Quadrantal System, the back bearing is equal to the fore bearing but the designating letters will be exactly opposite. N will be changed to S and vice versa and E will be changed to W and vice versa.

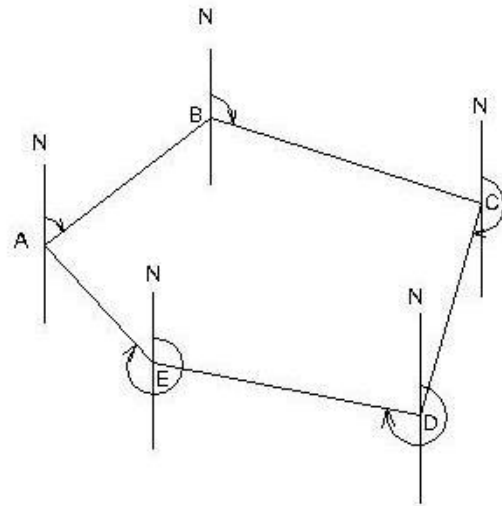
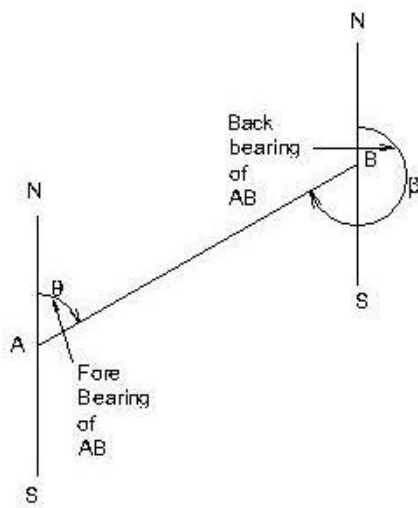

Calculation of Included Angles from Bearings

At the point where two survey lines meet, two angles are formed – an exterior angle and an interior angle. The interior angle or included angle is generally the smaller angle ($<180^\circ$). The difference of bearing of two adjacent lines is the included angle measured clockwise from the line whose bearing is less.

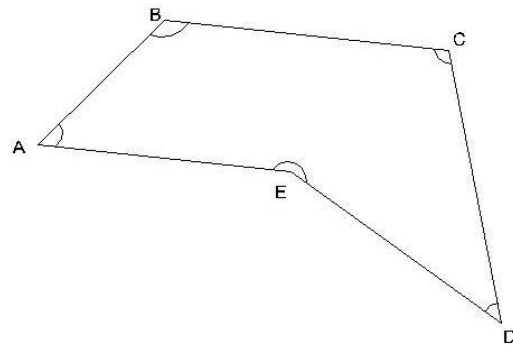
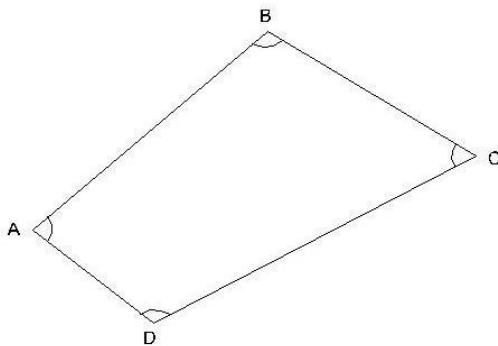

Calculation of Bearings from Included Angles.

In order to calculate the bearing of the next line the following statement may be made.
Add the included angle measured clockwise to the bearing of the previous line . If the sum is :

More than 180° , deduct 180°

More than 540° , deduct 540°

Less than 180° , add 180° , to get the bearing of the next line.

Note :

- In a closed traverse run in anticlockwise direction, the observed included angles are interior angles.
- In a closed traverse run in clockwise direction, the observed included angles are exterior angles.

Example : Find the included angle between lines AB and AC ,if their reduced bearing are

- | | | |
|------|-----------------------|----------------------|
| i) | AB N $40^\circ 10'$ E | ACN $89^\circ 45'$ E |
| ii) | AB N $10^\circ 50'$ E | ACS $40^\circ 40'$ E |
| iii) | AB S $35^\circ 45'$ W | ACN $45^\circ 20'$ E |
| iv) | AB N $30^\circ 25'$ E | ACN $30^\circ 25'$ W |

Bearings of AB = N $40^\circ 10'$ E; Bearing of AC = N $89^\circ 45'$ E
both lines lie in NE quadrant.

Included angle BAC = difference in the bearings = $89^\circ 45' - 40^\circ 10' = 49^\circ 35'$. **Ans.**

(ii)

Bearing of AB = N $10^\circ 50'$ E; Bearing of AC = S $40^\circ 40'$ E
lines lie in adjacent quadrants.

Included angle BAC = $180^\circ - \text{sum of the bearings} = 180^\circ - (10^\circ 50' + 40^\circ) = 128^\circ 30'$

(iii)

Bearing of AB = S $35^\circ 45'$ W
Bearing of AC = N $45^\circ 20'$ E

The lines lie in opposite quadrants,

Included angle CAB = $180^\circ - (\text{difference in bearings}) = 180^\circ - (45^\circ 20' - 35^\circ 45')$
 $= 170^\circ 25'$.

(iv)

Bearing of AB = N $30^\circ 25'$ E
Bearing of AC = N $30^\circ 25'$ W

The lines lie in adjacent quadrants.

The Included angle CAB = sum of the bearings = $30^\circ 25' + 30^\circ 25' = 60^\circ 50'$.

Example 2

The bearings of the sides of a closed traverse ABCDEA are as follow :

Side	F.B.	B.B.
AB	$107^{\circ} 15'$	$287^{\circ} 15'$
BC	$22^{\circ} 00'$	$202^{\circ} 00'$
CD	$281^{\circ} 30'$	$101^{\circ} 30'$
DE	$181^{\circ} 15'$	$1^{\circ} 15'$
EA	$124^{\circ} 45'$	$304^{\circ} 45'$

Compute the interior angles of the traverse and exercise necessary checks.,

Solution:

(i) The included angle A = The difference in bearings of AB and AE.

As the bearing of AB is less than of AB, add 360° .

$$\text{Included angle A} = 107^{\circ} 15' + 360^{\circ} - 304^{\circ} 45' = 162^{\circ} 30'$$

The included angle at B= The difference in bearings of BC and BA

$$= 22^{\circ} 00' + 360^{\circ} - 287^{\circ} 15'$$

$$\text{Included angle B} = 94^{\circ} 45'$$

The included angle at C= The difference in bearings of CD and CB

$$= 281^{\circ} 30' - 202^{\circ} 00' = 79^{\circ} 30'$$

$$\text{Included angle C} = 79^{\circ} 45'$$

The included angle at D= The difference in bearings of DE and DC

$$= 181^{\circ} 15' - 101^{\circ} 30' = 79^{\circ} 45'$$

$$\text{Included angle D} = 79^{\circ} 45'$$

The included angle at E= The difference in bearings of EA and ED

$$= 124^{\circ} 45' - 1^{\circ} 15' = 123^{\circ} 30'$$

. Included angle E = $123^{\circ} 30'$. **Ans.**

Check :

Sum of the included angles of a pentagon

$$= (2 \times 5 - 4) = 6 \text{ right angles.}$$

And, sum of the included angles A+B+C+D+E

$$= 162^{\circ} 30' + 94^{\circ} 45' + 79^{\circ} 30' + 79^{\circ} 45' + 123^{\circ} 30'$$

$$= 540^{\circ} 00' \text{ or } 6 \text{ right angles Hence ,O.K.}$$

Example

A closed compass traverse ABCD was conducted round a lake and the following bearings were obtained. Determine which of the stations are suffering from local attraction and give the values of the corrected bearings:

AB	$74^{\circ} 20'$	$256^{\circ} 0'$
BC	$107^{\circ} 20'$	$286^{\circ} 20'$
CD	$224^{\circ} 50'$	$44^{\circ} 50'$

DA	$306^{\circ} 40'$	$126^{\circ} 00'$
----	-------------------	-------------------

Solution:

On examination the fore and back bearings of CD differ exactly by 180° . Hence, stations C and D are free from local attraction. Stations affected by local attraction are A and B.

Calculation of included angles:

Interior angle at A = bearing of AD – bearing of AB

$$= 126^{\circ} 00' - 74^{\circ} 20' = 51^{\circ} 40'$$

$$\text{Exterior angle A} = 360^{\circ} - 51^{\circ} 40' = 308^{\circ} 20'$$

Interior angle at B = bearing of BA – bearing of BC

$$256^{\circ} 0' - 107^{\circ} 20' = 148^{\circ} 40'$$

$$\text{Exterior angle at B} = 360^{\circ} - 148^{\circ} 40' = 211^{\circ} 20'$$

Interior angle at C = bearing of CB – bearing of CD

$$= 286^{\circ} 20' - 224^{\circ} 50' = 61^{\circ} 30'$$

$$\text{Exterior angle at C} = 360^{\circ} 00' - 261^{\circ} 30' = 298^{\circ} 30'$$

Exterior angle D = bearing of DA – bearing of DC

$$= 306^{\circ} 40' - 44^{\circ} 50' = 261^{\circ} 50'$$

Check : Sum of exterior angles of the quadrilateral ABCD

$$(2 \times 4 + 4) = 12 \text{ right angles. O.K.}$$

Total sum of exterior angles

$$= 308^{\circ} 20' + 211^{\circ} 20' + 298^{\circ} 30' + 261^{\circ} 50'$$

$$= 180^{\circ} = 12 \text{ right angles. O.K.}$$

Calculation of bearing :

$$\text{Bearing of CD} \quad 224^{\circ} 50' \quad (\text{given})$$

$$\text{Add angle at D} = + 261^{\circ} 50'$$

$$\text{Sum} = 486^{\circ} 40'$$

$$\text{Sum is more than } 180^{\circ}, \text{ subtract} \quad = (-) 180^{\circ} 00'$$

$$\text{Bearing of DA} \quad = 306^{\circ} 40'$$

$$\text{Add angle at A} \quad = +308^{\circ} 20'$$

$$= 615^{\circ} 00'$$

$$\text{Sum is more than } 540^{\circ}, \text{ subtract} \quad = (-) 540^{\circ} 00'$$

$$\text{Bearing of AB} \quad = 75^{\circ} 00'$$

$$\text{Add traverse angle at B} + 211^{\circ} 20'$$

$$\text{Sum} = 286^{\circ} 20'$$

$$\text{Sum is more than } 180^{\circ}, \text{ subtract} - 180^{\circ} 00'$$

$$\text{Bearing of BC} \quad = 106^{\circ} 20'$$

$$\text{Add traverse angle at C} \quad + 298^{\circ} 30'$$

$$\text{Sum} \quad = 404^{\circ} 50'$$

$$\text{Sum is more than } 180^{\circ}, \text{ subtract} \quad - 180^{\circ} 00'$$

Bearing of CD = $224^{\circ} 50'$ checked

Result: Corrected bearings of the lines are:

Side	FB	BB
AB	$75^{\circ} 00'$	$225^{\circ} 0'$
BC	$106^{\circ} 20'$	$286^{\circ} 20'$
CD	$224^{\circ} 50'$	$44^{\circ} 50'$
DA	$106^{\circ} 40'$	$126^{\circ} 40'$

Effect of earth's magnetism:

The earth behaves like a strong magnet with its poles placed away from the geographic north and south poles. One pole of the earth's magnet is placed at approximately 70° north latitude and 96° west longitude in Canada and similar pole exists at a diametrically opposite location in the Southern hemisphere. A magnetic needle supported in such a way that it can rotate in a vertical plane will take up a vertical position at such a place. Since one end of a magnetic needle points to the north direction and is designed as the north pole of the needle, it is clear that the imaginary magnet inside the earth has its south pole there. This is because unlike poles attract each other. The north pole of a magnet is strictly the north-seeking pole.

The magnetic lines or forces due to earth's magnetism generally go from near the South pole to North pole. Such lines of force are parallel to the surface (horizontally) only near the equator. At other places, as these lines to the poles, they are direction as the lines of forces; it will dip (from the horizontal) by a small angle. This is known as the dip angle. The dip angle increases as we go from the equator to the poles.

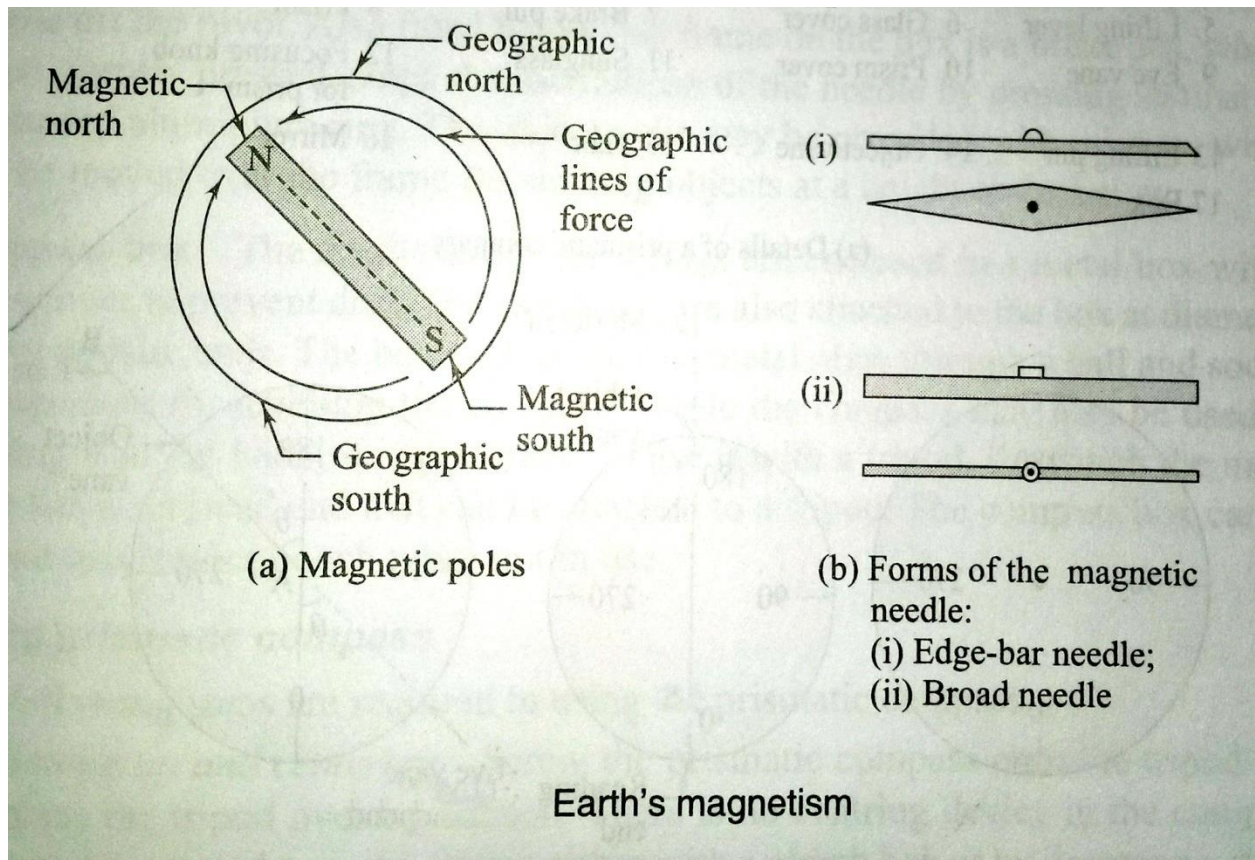

A magnet needle is generally made perfectly symmetrical and supported on a hard, pointed pivot. To make it take up a horizontal position, it is generally weighted with an adjustable weight. As the north pole or the north-seeking pole of the needle dips down in the Northern hemisphere, the needle is weighted in the southern segment of the needle there. Similarly, the northern segment of the needle is weighted in the Southern hemisphere. Shown in the plan and section of two forms of magnetic needles commonly used—one with pointed ends (edge-bar needle) and other of uniform width (broad form needle). The north pole, or the north-seeking pole, of a magnetic needle when freely suspended gives us the direction of the magnetic lines of the forces and this is used as a reference in compass surveying.

Magnetic Declination:

- The horizontal angle between true north and magnetic north at a place at the time of observation, is called magnetic declination.
- The angle of convergence between the true north and magnetic north at any place does not remain constant.
- It depends upon the direction of the magnetic meridian at the time of observation.
- If the magnetic meridian is on eastern side of true meridian, the angle of declination is said to be eastern declination or positive declination.
- On the other hand if the magnetic meridian is on western side, the declination is said to be western declination or negative declination is zero.
- The imaginary lines joining the places of equal declination either positive or negative, on the surface of the earth, are called “Isogonic lines”.
- The isogonics lines having zero declination are known as ‘Agonic lines’.

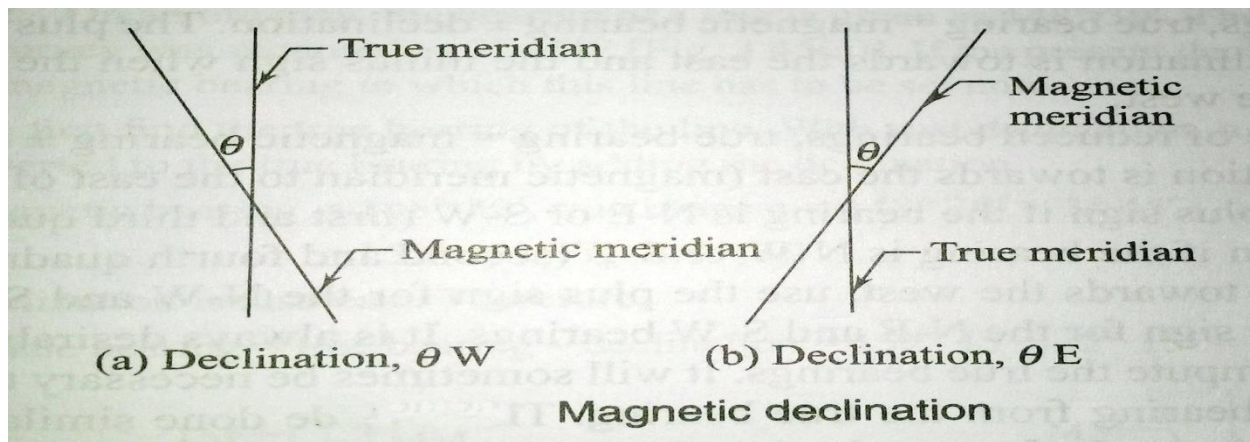

Mariners generally call magnetic declination as ‘**variation**’.

1. **Determination of Magnetic Declination:**

- True meridians at a number of places in the area, are determined by making astronomical observations (specially to stars).
- Compass observations are made by sighting the true meridians at the places
- The angle of inclination between true meridian and magnetic meridian given by a compass reading, is the desired magnetic declination at the place.
- Magnetic declination = True bearing – Magnetic bearing”.*

2. Calculation of True Bearing.

True Bearing = Magnetic bearing \pm magnetic declination,

use + ve sign if declination is east

and –ve sign, if it is west.

3. Calculation of Magnetic Bearing.

Magnetic bearing = True Bearing \pm magnetic declination,

use –ve sign for eastern declination and + ve sign for western declination.

Variation of Declination

Declination at my place does not remain constant but keeps on changing from time to time. These variations may be classified under four heads *viz.*

1. Secula variation

2. Annual variation

3. Diurnal variation

4. Irregular variation

1. Secular Variation.: The earth magnetic poles are continually changing their positions relatively to the geographical poles. Earth Magnetic meridian also changes and affects the declination of places. Secular variation is a slow continuous change and declination of places. Alters in a more and less regular manner from year to year. Due to its magnitude, secular variation is the most important for land surveyors. It appears to be of periodic character and follows a sine curve. The swing of declination at a place over a period of centuries, may be compared to a simple harmonic motion. A secular change from year to year is also not uniform for any given place. It is also different for different places. To convert magnetic bearings into true bearings, an accurate amount of declination is essentially required. As such it is very important for a surveyor to know the exact amount of declination. When observations for the declination are made in different years of a century, it is revealed that magnetic meridian moves from one side of true meridian to the other. The change produced annually by secular variation at different places amounts from 0.02 minute to 12 minute. The variation at depends upon the geographical position of different place. The annual secular change is greatest near the middle point of a complete cycle and least at it extreme limits.

2. Annual Variation.: Change in declination at a place over a period of one year, is known as annual variation. From the observations made at different places over a period of 12 months, it is found that annual variation is about 1 minute to 2 minutes, depending upon their geographical positions.

3. Diurnal Variation. The departure of declination from its mean value during a period of 24 hours at any place is called diurnal variation. The diurnal variation depends upon the following factors:

(1) **The geographical position of the place.** It is greatest for the places in higher latitudes and lesser near the equator.

(2) **Season of the year.** It is comparatively more in summer than in winter at the same place.

(3) **The time.** It is more in day and less at night.

(4) **The year of the cycle.** It is different for different years in the complete cycle of secular variation.

(4) Irregular Variation. Abrupt change of declinations at places due to magnetic storms, earthquakes and other solar influences, are called irregular variations. These disturbances may occur at any time at any place and cannot be predicted. The displacement of a needle may vary in extent from 1^0 to 2^0 .

Example. The true and magnetic bearings of a line are $78^0 45'$ and $75^0 30'$ respectively. Calculate the magnetic declination at the place.

Solution.

$$\begin{aligned}\text{Magnetic declination} &= \text{True bearing} - \text{Magnetic bearing} \\ &= 78^0 45' - 75^0 30' \\ &= 3^0 15'\end{aligned}$$

As the sign is + ve, declination is east of true meridian.

. Magnetic declination = $3^0 15'$ East.

6.5 Error in compass surveying:

The following errors are common in surveying with compass.

Instrumental errors:

It is caused by the defective parts of the instrument. These are

- (a) The needle may not be straight, giving wrong readings.
- (b) The pivot point may have become blunt and the needle may not move freely.
- (c) The line of sight may not pass through the centre of the graduated ring.
- (d) The ring may not move in a horizontal plane due to the dip of the needle as a result of the wrong adjustment of the balancing weight.
- (e) The cross hair in the objective vane may not be straight or may have become loose.

Personal errors:

- (a) Reading the graduations in the wrong direction or reading the quadrants wrongly.
- (b) Improper centering of the compass over the station.
- (c) Not leveling the compass properly.
- (d) Not bisecting the signal at a station properly.

Other errors:

- (a) Variation in declination during the day, when the survey is carried out over a long duration during the day
- (b) Local attraction due to the proximity of external magnetic influences at one or more stations
- (c) Other variations due to magnetic storms, cloud cover, etc, which affect the magnetic needle.

PRECAUTIONS TO BE TAKEN IN COMPASS SURVEY

The instrumental and observational errors during a compass survey may be minimized by taking the following precautions:

- Set up and level the compass carefully.
- Stop the vibrations of the needle by gently pressing the brake-pin so that it may come to rest soon.
- Always look along the needle and not across it, to avoid parallax.
- When the instrument is not in use, its magnetic needle should be kept off the pivot. If it is not done, the pivot is subjected to unnecessary wear which may cause sluggishness of the magnetic needle.
- Before taking a reading, the compass box should be gently tapped to ensure that the magnetic needle is freely swinging and has not come to rest due to friction of the pivot.
- Stations should be selected such that these are away from the sources of local attraction.
- Surveyor should never carry iron articles, such as a bunch of keys which may cause local attraction.
- Fore and back bearings of each line should be taken to guard against the local attraction. If the compass is not set at the end of a line, the bearings may be taken from any intermediate point along that line.
- Two sets of readings should be taken at each station for important details by displacing the magnetic needle after taking one reading.
- Avoid taking a reading in wrong direction viz. 25° to 20° instead 20° to 25° and so.
- If the glass cover has been dusted with a handkerchief, the glass gets charged with electrostatic current and the needle adheres to the glass cover. This may be obviated by applying a moist finger to the glass.
- Object vane and eye vane must be straightened before making observations.

MAINTENANCE OF PRISMATIC COMPAS:

The Prismatic compass is a fine instrument that is easy to set up and use. It is ideally suited for rough, speedy survey work. The following points are important for maintaining the compass in good condition. The compass comes in a leather cover. The compass should be kept in its cover when not in use.

- The compass should be tested frequently, before using it for surveying. Check regularly to see whether the magnetic needle is freely moving or sluggish.
- Set up the compass at a point and take the bearing of a line connecting to a well-defined object. Rotate the compass and immediately bring it back to the same point, bisect and take the reading. The reading should be the same. If not, the needle is not moving properly due to a blunt pivot.
- Check whether the needle (or the graduated ring) moves in a horizontal plane
- Keep the instrument free of dust and clean the glass cover with a fine cloth.

CHAPTER -6

6.0 CHAIN AND COMPASS SURVEYING

6.1 Principle of traversing

A series of connected straight line each joining two points on the ground is called a traverse. End points are known as traverse stations and straight lines between two consecutive station s are called traverse legs.

Traverse may be either a closed traverse or an open traverse.

Closed Traverse:

A traverse which either originate from a station and closes on same station or runs between two station whose co ordinates are known in terms of a common system of co ordinates is known as closed traverse. In closed traverse accuracy of linear as well as angular measurements may be known.

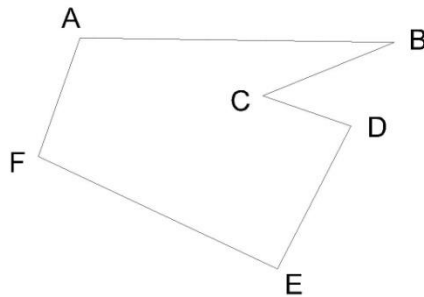

Closed Traverse

Open Traverse:

A traverse which neither returns to its starting station nor ends on another known station is known as open traverse .In open traverse accuracy of linear as well as angular measurement may not be checked.

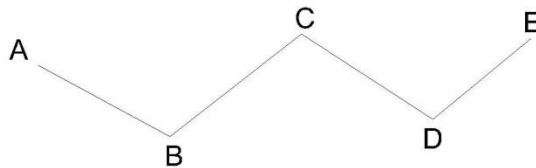

Open Traverse

Difference between Chain survey And Compass Survey

Chain survey is preferred to if the area to be surveyed is small in extent and higher accuracy is aimed at where as if the area is comparatively large with undulation and less accuracy is required, compass survey is adopted.

6.3 Local Attraction:

North end of a freely suspended magnetic needle always points to the magnetic north ,if not influenced by any other external forces except the earth's magnetic field.

The magnetic needle gets deflected from its normal position, if placed near magnetic rocks ,iron ores cables etc. such a disturbing force is known as local attraction.

Detection of local attraction:

The presence of local attraction at any station may be detected by observing the fore and back bearings of the line. If the difference between fore and back bearing is 180° , both end stations are free from local attraction. If not, the discrepancy may be due to:

- (1)An error in observation of either fore or back bearings or both.
- (2) Presence of local attraction at either station.
- (3) Presence of local attraction at both the stations.

The correction to other stations may be made according to the following methods.

- i) By calculating the included angles at the affected stations
- ii) By calculating the local attraction of each station and then applying the required corrections starting from the unaffected bearing.

Method of elimination of local attraction by in closed :

- i) Compute the included angles at each station from the observed bearing, in case of a closed traverse.
- ii) Starting from the unaffected line run down the correct bearing of the successive sides.

Method of elimination of local attraction by applying corrections to bearing in closed :

Following steps are followed

- i) Calculate the magnitude and direction of the error due to local attraction at each affected station
- ii) Run down bearing starting from the bearing unaffected by local attraction.

6.4 Methods of Plotting of Traverse:

Before plotting of traverse survey it should be checked whether the observed bearing are correct. If not the required correction to each bearing may be made so that the traverse will perfect in the geometrical figure based on field data.

The traverse may be plotted by one of the method

1.By Parallel Meridians; After deciding the layout of the traverse a line representing the magnetic meridian through the location of the station is drawn on the paper .The bearing of the line AB is plotted with the ordinary protractor and its length duly reduced to scale, is marked off to get the location of station A is drawn . The bearing of BC is plotted and length BC is plotted to scale .The process is continued till last station is plotted. In a close traverse last line should end on the starting station A. In case of a closed circuit or at any other known station in case of linear closed traverse. If dose not the distance between two locations of the same station is termed as closing error.

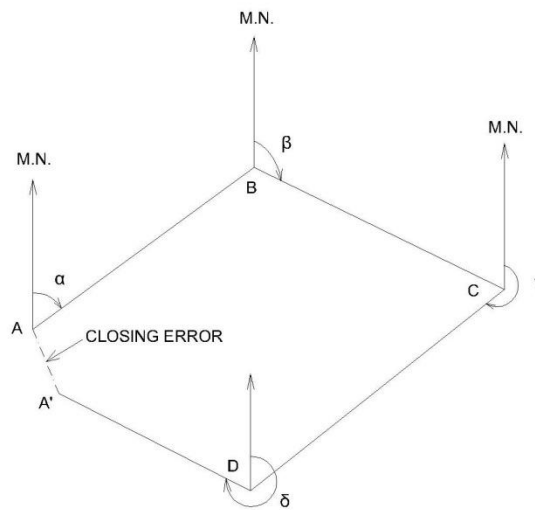

2. By Included Angles;

After deciding the location of the station A on the paper draw a line to represent the magnetic meridian passing through A. Plot the magnetic bearing of the chain line AB and plot AB duly reduced to scale. Now plot the included angle ABC by a protractor and plot the location of station C. The process is continued till all the stations are plotted. It may be noted that for a closed traverse if linear measurement between stations are correct and plotting is error less the closing station will coincide with the station A. If not the distance between two locations of the starting station is known as closing error.

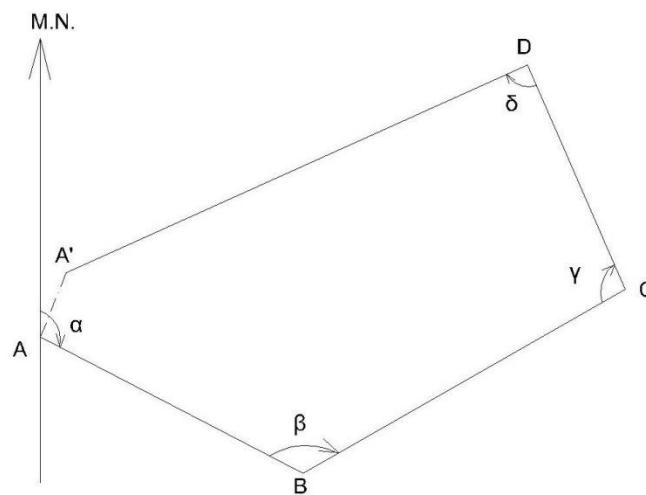

3. Plotting By tangents.

Deflection angles of the chain lines are plotted by geometry construction with the help of their natural tangents. The traverse may be plotted as followed.

From the location of the starting station A draw a line passing through A to represent its magnetic meridian. To draw the bearing of traverse leg AB cut a length of 10 cm on the magnetic meridian of station A at B₁. At B₁ erect a perpendicular B₁B₂ on the proper side of the meridian. Take B₁B₂ equal to 10 x tangent of the reduced bearing i.e angle of deflection of the line AB in centimeter.

Join AB₂ and produce it to get the direction of traverse line AB plot length of AB on the line AB₂ to a desired scale.

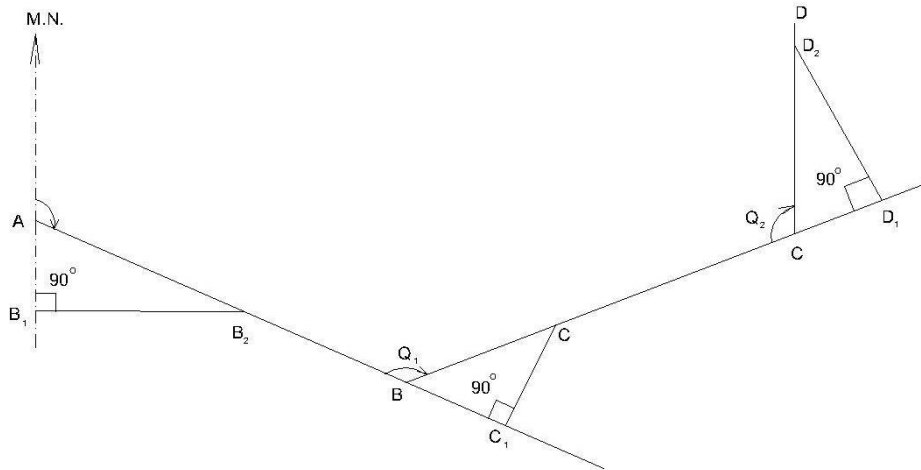

The Deflection angles of the successive chain lines for the purpose of plotting are obtained by the following formulae.

1. If the included angle between adjacent lines is between 0° and 90° , deflection angle is equal to the included angle.
2. If the included angle is between 90° and 180° , subtract the given included angle from 180° to get the deflection angle.
3. If the included angle is between 180° and 270° , subtract 180° from the given included angle.
4. If the included angle is between 270° and 360° , subtract the given included angle from 360° to get the deflection angle.

Continue the process till all the traverse legs are plotted.

Adjustment of Closing Error:

When a closed traverse is plotted from the field measurements, the end station of a traverse generally does not coincide exactly with its starting station. This discrepancy is due to the errors in the field observations i.e. magnetic bearings and linear distances. Such an error of the traverse is known as **closing error or error of closure**.

When the angular and linear measurements are of equal precision, graphical adjustment of the traverse may be made. This method is based on the Bowditch's rule. Corrections are applied to lengths as well as to bearings of the lines in proportion to their lengths. Graphical method is also sometimes known as proportionate method of adjustment.

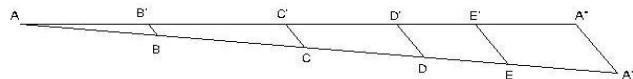
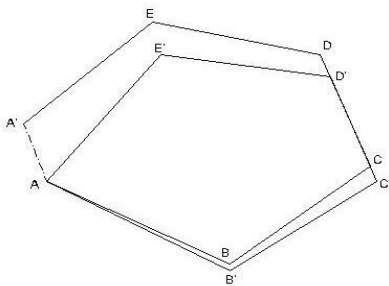

Method. The adjustment of a compass traverse graphically, may be made as follow:

Let ABCDEA' be a closed traverse as plotted from the observed magnetic bearings and linear measurements of the traverse legs. A is the starting station and A' is the location of the station A as plotted. Hence, A'A is the closing error.

Adjustment. Following procedure may be adopt.

- 1 Draw a straight line AA' equal to the perimeter of the traverse to any suitable scale.
- Set off the distances AB, BC, CD, DE, and EA' equal to the lengths of the sides of the traverse.
- Draw A'A'' parallel and equal to the closing error A'A.
- Draw parallel lines through points B, C, D, and E to meet AA'' at B', C', D' and E'.

- Draw parallel lines through the plotted stations B,C,D,E and plot the errors equal to BB',CC',DD' in the direction of A'A'.
- Join the points AB'C'D'E' A to get the adjusted traverse.

6.5 Error in chain and compass surveying:

Errors in Chaining:-

1. Incorrect length of chain
2. Incorrect ranging
3. Loose Chain
4. Temperature change
5. Variation in pull
6. Errors in slope measurement
7. Incorrect marking
8. Personal mistake

The following errors are common in surveying with compass.

Instrumental errors:

It is caused by the defective parts of the instrument. These are

- (a)The needle may not be straight, giving wrong readings.
- (b)The pivot point may have become blunt and the needle may not move freely.
- (c)The line of sight may not pass through the centre of the graduated ring.
- (d)The ring may not move in a horizontal plane due to the dip of the needle as a result of the wrong adjustment of the balancing weight.
- (e)The cross hair in the objective vane⁴ may not be straight or may have become loose.

Personal errors:

- (a)Reading the graduations in the wrong direction or reading the quadrants wrongly.
- (b)Improper centering of the compass over the station.
- (c)Not leveling the compass properly.
- (d)Not bisecting the signal at a station properly.

Other errors:

- (d) Variation in declination during the day, when the survey is carried out over a long duration during the day
- (e) Local attraction due to the proximity of external magnetic influences at one or more stations
- (f) Other variations due to magnetic storms, cloud cover, etc, which affect the magnetic needle.

PRECAUTIONS TO BE TAKEN IN COMPASS SURVEY

The instrumental and observational errors during a compass survey ,may be minimized by taking the following precautions:

- Set up and level the compass carefully.
- Stop the vibrations of the needle by gently pressing the brake-pin so that it may come to rest soon.
- Always look along the needle and not across it, to avoid parallax.
- When the instrument is not in use ,its magnetic needle should be kept off the pivot. If it is not done, the pivot is subjected to unnecessary wear which may cause sluggishness of the magnetic needle.
- Before taking a reading ,the compass box should be gently tapped to ensure that the magnetic needle is freely swinging and has not come to rest due to friction of the pivot.
- Stations should be selected such that these are away from the sources of local attraction.
- Surveyor should never carry iron articles, such as a bunch of keys which may cause local attraction.
- Fore and back bearings of each line should be taken to guard against the local attraction .If the compass is not be set at the end of a line, the bearings may be taken from any intermediate point along that line.
- Two sets of readings should be taken at each station for important details by displacing the magnetic needle after taking one reading.
- Avoid taking a reading in wrong direction viz. 25° to 20° instead 20° to 25° and so.

- If the glass cover has been dusted with a handkerchief, the glass gets charged with electrostatic current and the needle adheres to the glass cover .This may be obviated by applying a moist finger to the glass.
- Object vane and eye vane must be straightened before making observations.

7.Computation of Area

Introduction:-

It is the space of a tract of land projected upon the horizontal plane and not to the actual area of the land surface.

It may be expressed in Square metres(m^2),Hectares(1 hectare= 10000 m^2),Square feet,Acre.

Methods for computation of area:-

There are two methods of computation of the Area:-

A. *Graphical method*

B. *Instrumental method*

Calculation of area from Graphical method:-

The area may be calculated in two following ways:-

- i.From field Notes
- ii.From Plotted plan

Computation of the area from field notes

In this method the computation of the area is done in two steps:-

- a. In survey works the whole area is divided into number of some geometrical Fig. such as triangles, rectangles, square, trapeziums and then the area is calculated.
- b. Then the area of this geometrical fig. added up to get the required area.

Calculation of the area from Plotted plan:-

The area may be calculated in two following ways:-

- i.Considering the entire area
- ii.Considering the Boundary area

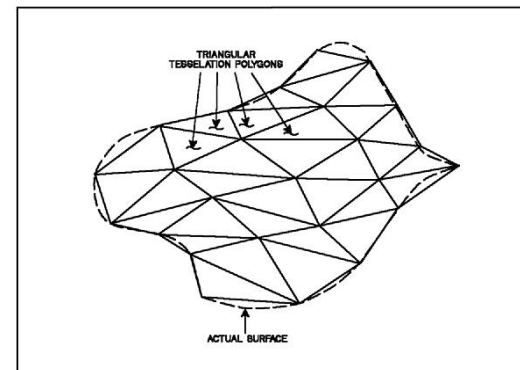

Considering the Entire area:-The entire area is divided into regions of convenient shape and they are calculated by

a. **By dividing the area into triangles:-** The triangles are so drawn as to equalize the irregular boundary line. Then the bases and altitude of the triangles are determined according to the scale to to which plan is drawn. After this the areas of these triangles are calculated.(fig.1)

b. **By dividing the area into squares:-** In this method squares of equal size are ruled out on a piece of tracing paper. Each square represents a unit area which could be 1cm^2 or 1m^2 .The tracing paper is placed over the plan and the full squares are counted. The total area is then calculated by multiplying the number of squares by the unit area of each square

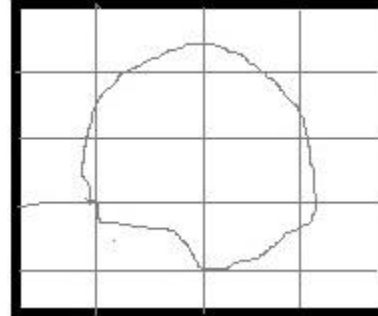

c. **By drawing parallel lines and converting them into rectangles:-** In this method, a series of equidistant parallel lines are drawn on a tracing paper. The constant distance represents a metre or cm. The tracing paper is placed over the plan in such a way the area is enclosed between parallel lines at the top and bottom. Thus the area is number of strips. The curved ends of the strips are replaced by perpendicular lines and no. of rectangles are formed. The sum of the lengths of the rectangles is then calculated.

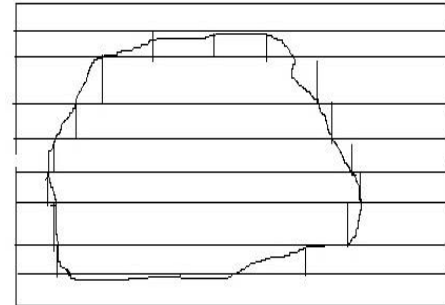

Required Area= \sum length of rectangle X constant distant

Considering the Boundary area:-In this method the large square or rectangle is formed with in the area in the plan. The ordinates are drawn at a regular interval from side of the square to the curved boundary. The middle area is calculated in the usual manner. The boundary area is calculated by

a. Mid Ordinate rule

b. Average ordinate rule

c. Trapezoidal rule

d. Simpson's rule

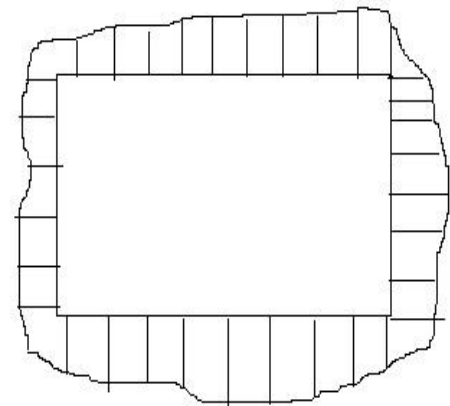

Mid Ordinate rule:-

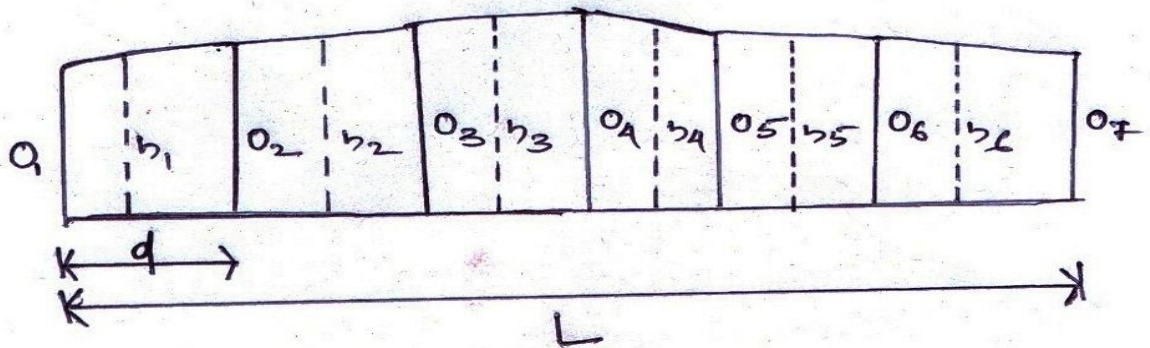

Let

$O_1, O_2, O_3, O_4, O_5, O_6, O_7, \dots, O_n$ = ordinates at equal intervals

L = length of the base line

d = Common distance between ordinates

$h_1, h_2, h_3, h_4, h_5, h_6, h_7, \dots, h_n$ = mid ordinates

Area of the plot = $(h_1 \times d) + (h_2 \times d) + (h_3 \times d) + (h_4 \times d) + \dots + (h_n \times d)$

$$= d(h_1 + h_2 + h_3 + h_4 + h_5 + h_6 + h_7 + \dots + h_n)$$

Where $h_1 = (O_1 + O_2)/2$ and so on

Therefore the required area = common distance \times sum of the mid ordinates.

Average ordinate rule:-

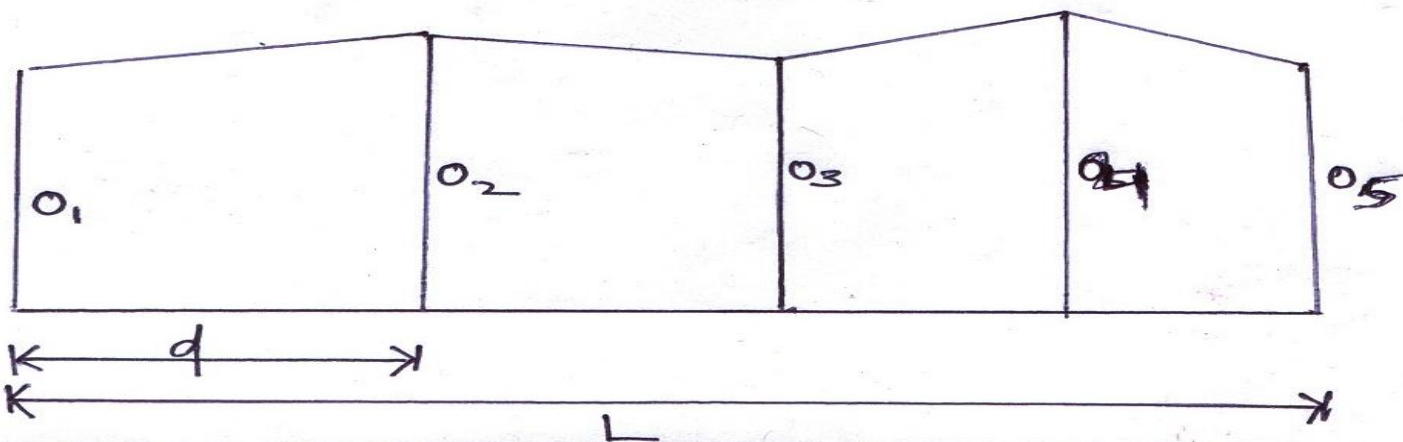

Let $O_1, O_2, O_3, O_4, O_5, O_6, \dots, O_n$ = ordinates or offsets at regular intervals

L = length of the base line

n = no. of divisions

$n + 1$ = number of ordinates

$$\text{Area} = \frac{(O_1 + O_2 + O_3 + O_4 + O_5 + O_6 + \dots + O_n)}{n + 1} \times L$$

Trapezoidal rule:-

While applying the trapezoidal rule boundaries between the ends of the ordinates are assumed to be straight. So, the area enclosed between the base line and the irregular boundary lines are to be considered as trapezoids.

Let, $O_1, O_2, O_3, O_4, O_5, O_6, O_7, \dots, O_n$ = ordinates at equal intervals

d = Common distance between ordinates

L = length of the base line

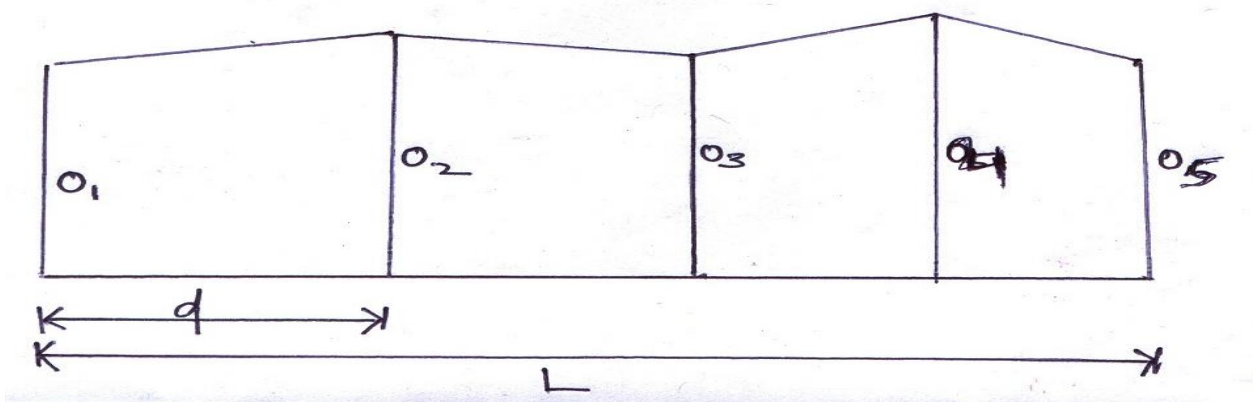

There fore,

$$1^{st} \text{ area} = \frac{O_1 + O_2}{2} \times d$$

$$2^{nd} \text{ area} = \frac{O_2 + O_3}{2} \times d$$

$$3^{rd} \text{ area} = \frac{O_3 + O_4}{2} \times d$$

$$4^{th} \text{ area} = \frac{O_4 + O_5}{2} \times d$$

..... and so on
 Last area = { (O_{n-1} + O_n) X d} / 2

There fore the required area = 1st area + 2nd area + 3rd area + 4th area +..... +
 Last area

$$\begin{aligned}
 &= [\{ (O_1+O_2) _X d\} / 2] + [\{ (O_2+O_3) _X d\} / 2] + [\{ (O_3+O_4) _X \\
 &d\} / 2] + [\{ (O_4+O_5) _X d\} / 2] + \\
 &.....+ \{ (O_{n-1} + O_n) X d\} / 2. \\
 &= d/2(O_1+ O_2 +O_2 +O_3 + O_3+ O_4+ O_4+ O_5+ O_5+ \\
 &.....O_n) \\
 &= d/2(O_1 + 2O_2+ 2O_3+ 2 O_4+ 2 O_5 +..... +O_n) \\
 &= \underline{\text{common distance}} \{ (1^{\text{st}} \text{ ordinate} + \text{last ordinate}) + 2(\text{sum of the} \\
 &\text{other ordinates})
 \end{aligned}$$

2

Therefore the **Trapezoidal rule** states that the sum of the first and last ordinate, twice the sum of the intermediate ordinates is added. This total sum is multiplied by the common distance . Half of this product is the required area.

Limitation:- There is no limitation. This rule can be applied for any number of ordinates

Simpson’s rule:-

In this rule the boundaries between the ends of the ordinates are assumed to form an arc of parabola. Hence Simpson’s rule is also known as parabolic rule . This rule is also known as Prismoidal rule.

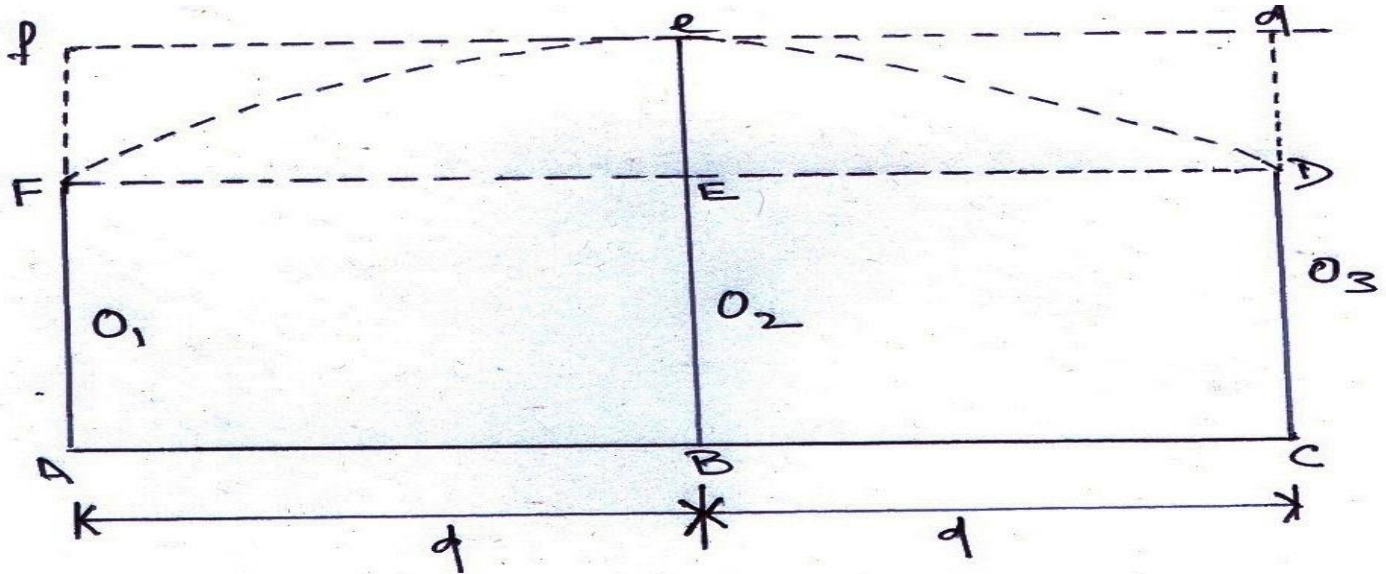

Let O_1, O_2, O_3 = three consecutive ordinates
 d = Common distance between ordinates

Therefore the required area $AFeDC$ = Area of the trapezium $AFDC$ + Area of the segment $FeDEF$

$$\text{Area of the trapezium } AFDC = \frac{O_1 + O_3}{2} \times 2d$$

$$\begin{aligned} \text{Area of the segment } FeDEF &= \frac{2}{3} \times \text{area of the parallelogram} \\ &= \frac{2}{3} (Ee \times 2d) = \frac{2}{3} \times \left\{ O_2 - \frac{O_1 + O_3}{2} \right\} \times 2d \end{aligned}$$

So, the area between the first two division is

$$\begin{aligned} A_1 &= \left[\frac{O_1 + O_3}{2} \times 2d \right] + \left[\frac{2}{3} \times \left\{ O_2 - \frac{O_1 + O_3}{2} \right\} \times 2d \right] \\ &= \frac{d}{3} (O_1 + 4O_2 + O_3) . \end{aligned}$$

Similarly, the area between two next division is calculated.....

$$A_2 = \frac{d}{3} (O_3 + 4O_4 + O_5) .$$

$$A_3 = \frac{d}{3} (O_5 + 4O_6 + O_7) \text{ and so on}$$

$$\text{Required area} = A_1 + A_2 + A_3 + \dots + A_n$$

$$\begin{aligned} &= \left\{ \frac{d}{3} (O_1 + 4O_2 + O_3) \right\} + \left\{ \frac{d}{3} (O_3 + 4O_4 + O_5) \right\} + \left\{ \frac{d}{3} (O_5 + 4O_6 + O_7) \right\} + \dots \\ &+ \left\{ \frac{d}{3} (O_{n-2} + 4O_{n-1} + O_n) \right\} \end{aligned}$$

$$= d/3[O_1 + O_n + 4(O_2 + O_4 + O_6 + \dots + O_{n-1}) + 2(O_3 + O_5 + O_7 + \dots + O_{n-2})]$$

$$= \frac{\text{common distance}}{3} \times \{ (1^{\text{st}} \text{ ordinate} + \text{last ordinate}) + 4 \times (\text{sum of the even ordinates}) + 2 \times (\text{sum of the odd ordinates}) \}$$

Therefore **Simpson's Rule** states that the sum of the first and last ordinate, four times the sum of the remaining even ordinates and twice the sum of the remaining odd ordinates are added. This total sum is multiplied by the common distance. One third of this product gives the required area.

Limitation:- This rule is only applicable when the number of divisions is even and ordinates are odd.

Difference between the Trapezoidal rule and Simpson's rule

Sl.no	Trapezoidal rule	Simpson's rule
1.	The boundary between the ordinates is considered to be straight	The boundary between the ordinates is considered to be arc of a parabola
2.	There is no limitation. It can be applied for any number of ordinates	This rule is only applicable when the number of divisions is even and ordinates are odd.
3.	It gives an approximate result.	It gives an accurate result.

.....*****

7. Plane Table Survey

Definition:-

A **plane table** is a device used in [surveying](#) and related disciplines to provide a solid and level surface on which to make field drawings, charts and maps. The early use of the name *plain table* reflected its simplicity and plainness rather than its flatness.

Objectives:-

- It is suitable for location of details as well as contouring for large scale maps directly in the field.
- As surveying and plotting are done simultaneously in the field, chances of getting omission of any detail get less.
- The plotting details can immediately get compared with the actual objects present in the field. Thus errors as well as accuracy of the plot can be ascertained as the work progresses in the field.
- Contours and specific features can be represented and checked conveniently as the whole area is in view at the time of plotting.
- Only relevant details are located because the map is drawn as the survey progresses. Irrelevant details get omitted in the field itself.
- The plane table survey is generally more rapid and less costly than most other types of survey.
- As the instruments used are simple, not much skill for operation of instruments is required. This method of survey requires no field book.

Disadvantage:-

- The plane table survey is not possible in unfavorable climates such as rain, fog etc.
- This method of survey is not very accurate and thus unsuitable for large scale or precise work.
- As no field book is maintained, plotting at different scale require full exercise.
- The method requires large amount of time to be spent in the field.
- Quality of the final map depends largely on the drafting capability of the surveyor.
- This method is effective in relatively open country where stations can be sighted easily

Principle :-

The principle of plane table survey is **Parallelism** ,It means that the ray drawn from station to objects on the paper are parallel to the lines from the station to the objects on the ground.

Accessories of plane table:-

- a. Plane table
- b. Alidade

c. The Spirit level

d. The compass

e. The U – Fork or plumbing Fork with plum bob

a. **The Plane Table:-**

i. The plane table is a drawing board of size 750mm X 600mm made of well seasoned wood like Teak, pine, etc.

ii. The top surface of the table is well levelled .

iii. The bottom surface consists of a threaded circular plate for fixing the table with the tripod stand by a wing nut.

iv. The plane table is meant for fixing the a drawing sheet over it.

v. The position of the objects are located on this sheet by drawing rays and plotting to any suitable scale.



b. **Alidade:-**

There are two types of alidade –Plain and telescopic alidade.

1.Plain alidade:-the plain alidade consists of a metal or wooden ruler of length about 50cm. one of its edge is beveled, and is known as fiducial edge. It consists of two vanes at both ends which are hinged with the ruler. One is known as object vane and the other is known as sight vane.

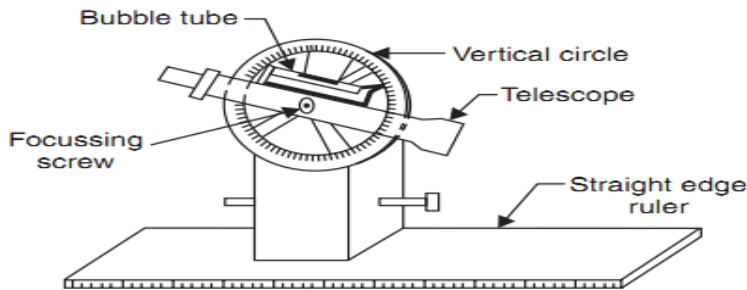
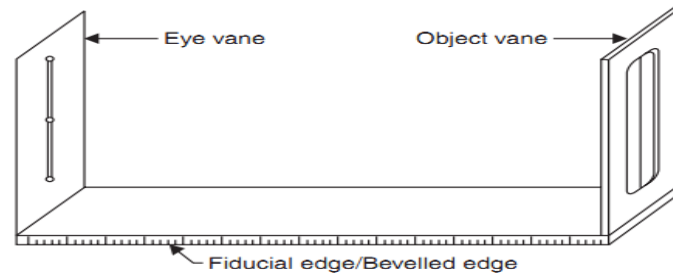

provided with the fiducial edge

2.Telescopic alidade:-The telescopic alidade consists of a telescope meant for inclined sight or sighting distant objects clearly. The alidade has no vanes at the ends, but is

The function of the alidade is to sight objects. The rays should be drawn along the fiducial edge.

c. **The Spirit level:-** It is a smaller metal tube containing a small bubble of spirit . The bubble is visible on the top along a graduated glass tube. The spirit level is meant for leveling the plane table.



d. **The compass:-** There are two kinds of compass

i. The trough compass

ii. The circular box compass.

i. **The trough compass:-** It is rectangular box made of non magnetic metal containing a magnetic needle pivoted at the centre. This compass consists of '0' mark at both the ends to locate N-S direction.

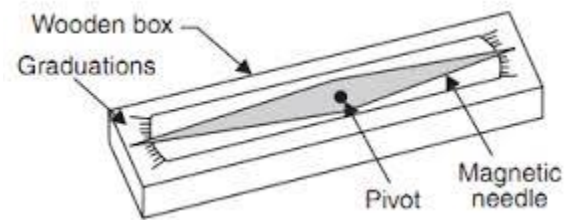

ii. **The Circular box compass:-** It carries a pivoted magnetic needle at the centre. The circular box is fitted on square base plate . Sometimes two bubble tubes are fixed at the right angles to each other on the base plate. The compass is meant for making the north direction of the map.

e. **The U – Fork or with plum bob:-** metal strip bent in the (Hair pin) having The top arm is bottom arm carries a

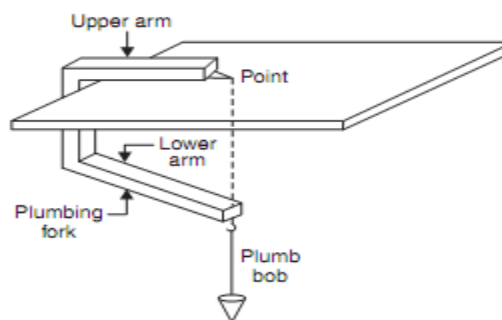

plumbing Fork

The U- fork is a shape of a 'U' equal arm lengths. pointed and the hook for suspending

a plumb bob .

This is meant for centering the table over a station.

Procedure of setting up plane table over a station

The following five steps should be followed while setting up a plane table over a station:-

1. **Fixing the table on the tripod stand:-** The tripod stand is placed over the required station with its legs well apart. Then the table is fixed on it by a wing nut at the bottom.

2. **Levelling the Table:-** The Table is levelled by placing the spirit level at different corners and various positions of the table. The bubble is brought to the centre of its run at every position of the table by adjusting the legs.

3. **Centring the table:-** At first the Drawing sheet is fixed on the table. A suitable point is selected on the sheet to represent the station "A" on the ground.

A pin is then placed on this selected point.

The upper end of the U-Fork is made in contact with the station pin and the plumb bob is suspended from the hook at the lower end. It is brought over the station "A" by turning the table clockwise or anticlockwise or slightly adjusting the table or legs.

This operation is called Centering and the table is clamped. Care should be taken that this operation should be done without disturbing the Leveling

4. **Marking the North line:-** The trough compass is placed on the right hand top corner of the drawing sheet with its north end approximately towards the north. Then the compass is turned clockwise or anticlockwise so that the needle exactly coincides with the 0-0 mark. Now a line representing the north line is drawn through the edge of the compass. It should be ensured that the table is not turned.

5. **Orientation:-** When the plane table survey is to be conducted by connecting several stations, the orientation must be performed at successive stations. It may be done by two methods

a. Backsighting method b. magnetic needle method.

a. **Back sighting Method:-**

This method is accurate and is always preferred. The following steps are followed during the back sighting method .

- i. Suppose A and B are two station . The plane table set up over A. The table is leveled by the spirit level and centered by the U- Fork so that the point a is just over station A. The north line is marked at the right hand top corner of the sheet by the compass.
- ii. With the help of the alidade touching the point a The ranging rod at B is bisected and ray is drawn . the distance AB is measured and plotted to any suitable scale. So the point b is represents station B
- iii. The table is shifted and set up over B. It is leveled and centered so that b is just over B. Now the alidade is placed along the line ba, and the ranging rod at A is bisected by turning the table clockwise or anticlockwise. At this time the centering may be disturbed and should be adjusted immediately if required .When the centering, leveling and bisection of ranging rod at A are perfect, then the orientation is said to be perfect.

b. Magnetic needle Method:-This method is suitable when the local attraction is not suspected. The following steps are followed during the magnetic needle method.

- i. i. Suppose A and B are two station . The plane table set up over A. The table is leveled by the spirit level and centered by the U- Fork so that the point a is just over station A. The north line is marked at the right hand top corner of the sheet by the compass in such a way that the neddle coincides with 0-0 mark . after this a line representing the north line is drawn through the edge of the compass box. Then the table is clamped.
- ii. With the help of the alidade touching the point a The ranging rod at B is bisected and ray is drawn . the distance AB is measured and plotted to any suitable scale. So the point b is represents station B
- iii. The table is shifted and set up over B. It is leveled and centered so that b is just over B. The table is leveled. Now the compass is just exactly over the north line drawn previously. The table is then turned clockwise or anticlockwise until the needle coincides with 0-0 mark of the compass. While turning the table it should be kept in mind that the centering and leveling is not disturbed. In case it is disturbed it should be adjusted immediately.
- iv. When the centering and leveling are perfect and the needle is exactly at 0-0 mark , the orientation is said to be perfect.

Methods Of Plane Table.:-

There are four methods of plane table. They are

- Radiation
- Intersection
- Traversing

Resection

Radiation:-

This method is suitable for locating the objects from a single station.

In this method rays are drawn from the station to the objects and the distances from the station to the object are measured and plotted to any suitable scale along the respective rays.

Procedure:-

- i. Suppose O is a station on the ground from where the objects A, B, C, & D are visible.
- ii. The plane table set up over at P. A drawing sheet is fixed on the table, which is then leveled and centered. A point o is selected on the sheet to represent the point o .
- iii. The North line is marked on the right hand top corner of the drawing sheet with the trough compass.
- iv. With the alidade touching the point o , Ranging rod at A, B, C, & D are bisected and the rays are drawn.
- v. The distances OA, OB, PC, & OD are measured and plotted to any suitable scale to obtain the points a, b, c, & d representing A, B, C, & D on the paper.

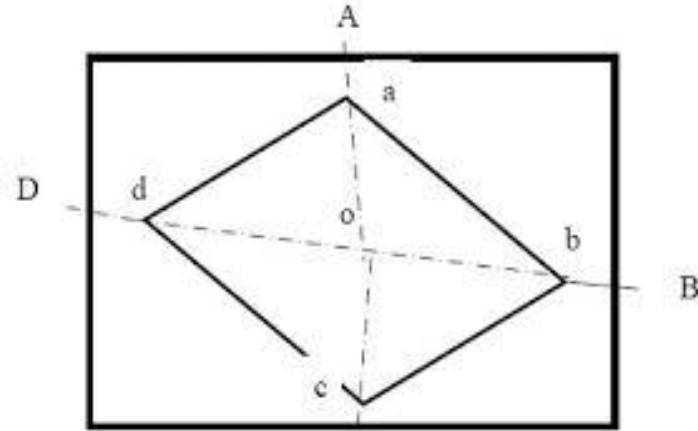

Intersection:-

This method is suitable for locating inaccessible points by the intersection of the ray drawn from two station instrument station.

Procedure:-

- i. Suppose A & B are two station and P is an object on the far bank of the river. It is required to fix the position of P on the sheet by the intersection of the rays drawn from A and B.
- ii. The table is set up at A. it is leveled and centered so that a point a on the sheet is just over the

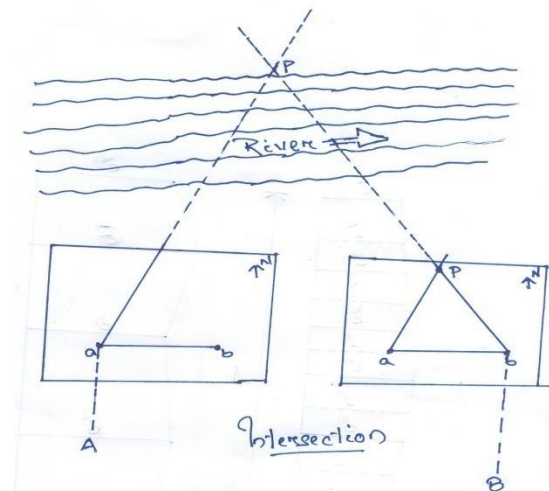

station A. The North line is marked on the right hand top corner of the drawing sheet with the trough compass.

- iii. With the alidade touching the point a the object P and the ranging rod at B are bisected and rays are drawn through the fiducial edge of the alidade.
- iv. The distance AB is measured and plotted to any suitable scale to obtain the point b .
- v. The table is shifted and centered over B and leveled properly. Now the alidade is placed along the line ba and orientation is done by back sighting. While backsighting it should be kept in mind that the centering and leveling is not disturbed. In case it is disturbed it should be adjusted immediately.
- vi. With the alidade touching b , the object P is bisected and ray is drawn. Suppose this ray intersects the previous ray at a point p . This point p is the plotted position of P.

Traversing:-

This method is suitable for connecting the traverse station

Procedure:-

- i. Suppose the P,Q,R,& S are the traverse stations.
- ii. The table is set up at the station P. A suitable point is selected on the drawing sheet let it be p such that the whole area may be plotted on the drawing sheet. The table well leveled, centered and the north line is marked on right hand top corner of the sheet.
- iii. With the alidade touching the point p the ranging rod at Q is bisected and the ray is drawn. The distance PQ is measured and plotted to any suitable scale to obtain the point q .

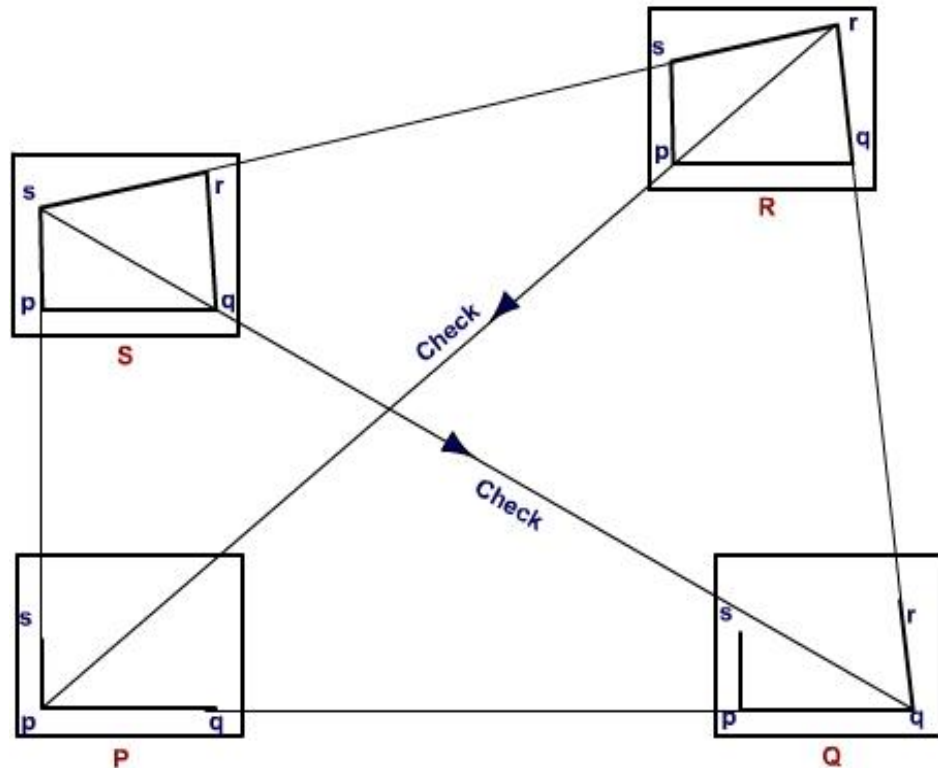

- iv. The table is shifted and set up over the station Q. It is then well leveled, centered, and oriented by back sighting and clamped.
- v. With the alidade touching the point q the ranging rod at R is bisected and the ray is drawn. The distance QR is measured and plotted to any suitable scale to obtain the point r
- vi. The table is shifted and set up over the station R. It is then well leveled, centered, and oriented by back sighting and clamped.
- vii. With the alidade touching the point r the ranging rod at S is bisected and the ray is drawn. The distance RS is measured and plotted to any suitable scale to obtain the point s
- viii. The table is shifted and set up over the station S. It is then well leveled, centered, and oriented by back sighting and clamped.
- ix. With the alidade touching the point s the ranging rod at P is bisected and the ray is drawn.
- x. At the end the finishing point may not coincide with the starting point and there may be closing error. This error is adjusted graphically by Bowditch's rule.
- xi. After making the correction for closing error the table is again setup over at A. After (well leveled, centered, and oriented by back sighting the surrounding are located by radiation).
- xii. The table is then shifted and set up at all station of the traverse and proper adjustments the details are located by the radiation and intersection methods.

Resection method:-

This method is suitable for establishing new stations at a place in order to locate missing details.

Procedure

(a) Suppose it is required to establish a station at position on P. Let us select two points A and B on the ground. The distance AB is measured and plotted to any suitable scale. This line AB is known as the "base line".

(b) The table is set up at A. It is leveled; centered and oriented by bisecting the ranging rod at B. the table is then clamped.

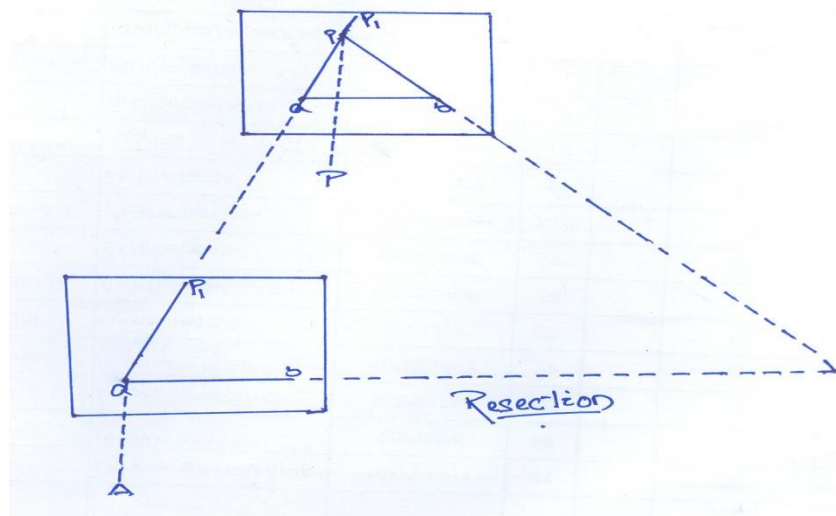

(c) With the alidade touching point *a*, the ranging rod at P is bisected and a ray is drawn .Then a point P_1 is marked on this ray by estimating with the eye.

(d) The table is shifted and centered in such a way that P_1 is just over P. It is then oriented by back sighting the ranging rod at *a*.

(e) With the alidade touching point *b*, the ranging rod at B is bisected and a ray is drawn .Suppose this ray intersects the previous ray at a point P. This point represents the position of the station P on the sheet. Then the actual position of the station P is marked on the ground by U-fork and plumb bob.

Resection method based on (1)the two-point problem, and (2) the three-point problem.

1. Two point problem:-

In problem ,two well defined points whose position have already been plotted on the plan and selected . then by perfectly bisecting these points a new station is established at the required position.

Procedure:-

a. Suppose A and B are two well defined points whose position are plotted on map as *a* and *b* . it is required to locate a new station at P by perfectly bisecting A and B

b. An auxiliary station Q is selected at a suitable position on the ground. The table is set up at Q and it is leveled; centered and oriented by an eye estimate. It is then clamped.

c. With the alidade touching *a* and *b* the points A and B are bisected and a ray is drawn suppose these ray meet at *q*

d. with the alidade centered on

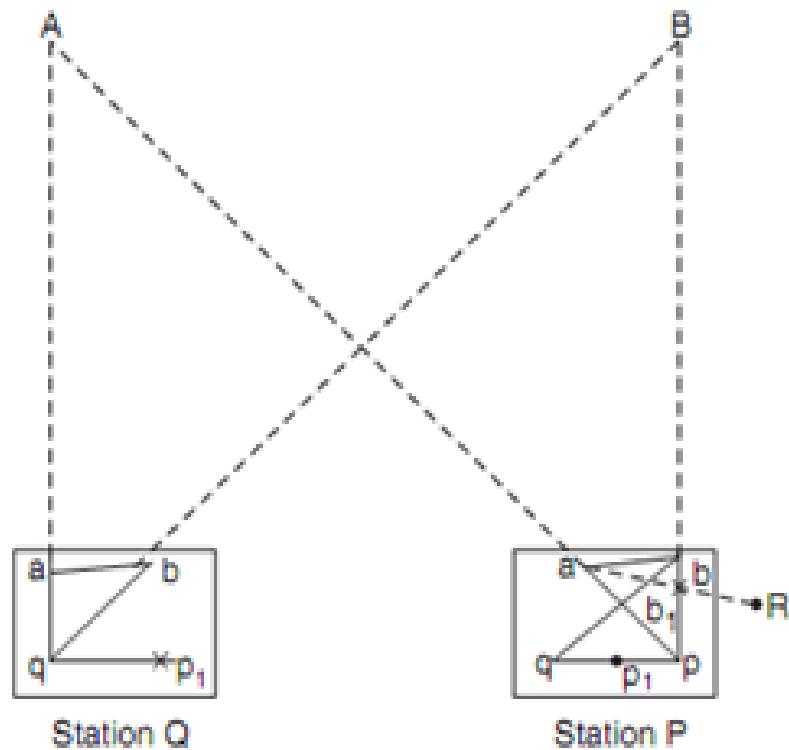

q the ranging rod at A is bisected and a ray is drawn . Then by eye estimation a point p_1 is marked on this ray.

e. The table is then shifted and centered on P with p_1 just over P. It is then leveled and oriented by the backighting. With the alidade touching the point a the point A is bisected and the ray is drawn . Suppose this ray intersects at pq_1 at the point q_1 as assumed previously.

f. With the alidade centered on p_1 the point B is bisected and a ray is drawn .Suppose this ray intersect the ray qb at a point b_1 . The triangle abb_1 is known as triangle of error and is to be eliminated.

g. The alidade placed along the line ab_1 and a ranging rod R is fixed at some distance from the table. Then the alidade placed along the line ab and the table is turned to bisect R. at this position the table is said to be perfectly oriented.

(h) Finally, with the alidade centered on p and q , the points p and Q are bisected and rays are drawn. Suppose these rays intersect at a point a . This would represent the exact position of the required station A. Then the station A is marked on the ground.

2. The Three-point problem :-

in this problem, three well defined points are selected whose positions have already been plotted on the map. Then, by perfectly bisecting these three well-defined points, a new station is established at the required position.

No auxiliary station is required in order to solve this problem. The table is directly placed at the

required position. The problem may be solved by three methods (a) the graphical or Bessel's method, (b) the mechanical method, and (c) the trial and error method.

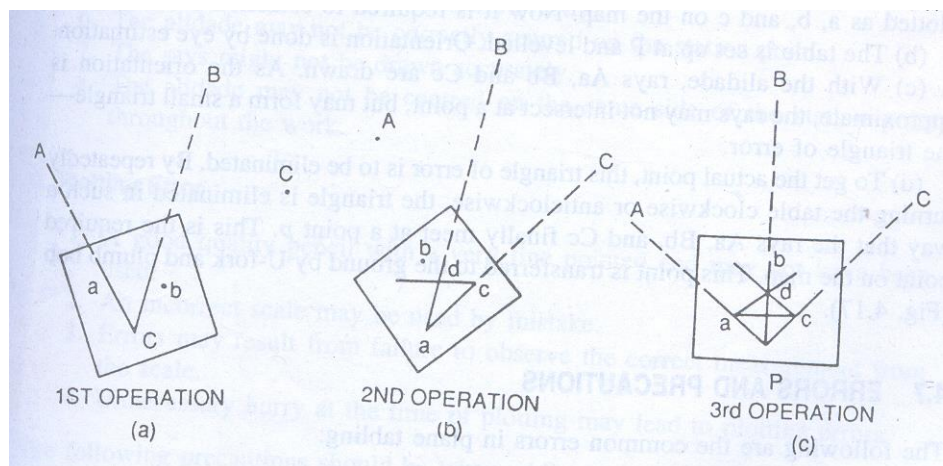

- (a) The Graphical method
- (1) Suppose A, B and C are three well-defined points which have been plotted as a, b and c. Now it is required to locate a station at P.
 - (2) The table is placed at the required station P and leveled. The alidade is placed along the line ca and the point A is bisected and ray drawn.
 - (3) Again the alidade is placed along the line ac and the point c is bisected and the table is clamped. With the alidade touching a, the point b is bisected and a ray is drawn. Suppose this ray intersects the previous ray at a point d .

The alidade is placed along db and the point B is bisected. At this position the table is said to be perfectly oriented. Now the rays Aa, Bb and Cc are drawn. These three rays must meet at a point p which is the required point on the map. This point is transferred to the ground by U-fork and plumb bob.

Errors and Precautions:-

A. Instrumental Errors

1. The surface of table may not be perfectly level.
2. The fiducial edge the alidade might not be straight.
3. The vanes may not be vertical.
4. The horsehair may be loose and inclined.
5. The table may be loosely joined with the tripod stand.
6. The needle of the through compass may not be perfectly balanced. Also it may not be able to move freely due to sluggishness of the pivot point.

B. Personal Errors

1. The leveling of the table may not be perfectly.
2. The table may not be centred properly.
3. The orientation of the table may not be proper.
4. The table might not be perfectly clamped.
5. The objects may not be bisected perfectly.
6. The alidade may not be correctly centred on the station point.
7. The rays might not be drawn accurately.
8. The alidade may not be centred on the same side of the station point throughout the work.

C. Plotting Error

1. A good quality pencil with a very fine pointed end may not have been used.
2. An incorrect scale may be used by mistake.

3. Errors may result from failure to observe the correct measurement from the scale.
4. Unnecessary hurry at the time of plotting may lead to plotting errors.

The following precautions should be taken while using the plane table;

1. Before starting the work the equipments for survey work should be verified. Defective accessories should be replaced by perfect equipment.
2. The centering should be perfect.
3. The leveling should be proper.
4. The orientation should be accurate.
5. The alidade should be centred on the same side of the station-pin until the work is completed.
6. While shifting the plane table from one station to another, the tripod stand should be kept vertical to avoid damage to the fixing arrangement.
7. Only the selected scale should be on the table.
8. Measurements should be taken carefully from the scale while plotting.
9. The stations on the ground are marked A, B, C, D etc. while the station points on the map are marked a, b, c, d etc.

Procedure of Field work

1. **Reconnaissance** –

The area to be surveyed is thoroughly examined to find the best possible way for traversing. The traverse stations should cover the whole area and should be indivisible. The provisions for check lines should be kept in mind.

2. **Marking the stations**

The selected stations are marked on the ground by wooden pegs. Reference sketches should be prepared for the stations so that they can be readily located in case the station pegs are removed.

.....*****.....

